

# SAMSUNG Interactive Display

## User Manual

---

WA65C WA75C WA86C

---

The color and the appearance may differ depending on the product, and the content in the manual is subject to change without prior notice to improve the performance.

Recommended hours of use per day of this product is under 16 hours. If the product is used for longer than 16 hours a day, the warranty may be void.

© Samsung

Samsung owns the copyright for this manual. Use or reproduction of this manual in parts or entirety without the authorization of Samsung is prohibited.

Trademarks other than Samsung are property of their respective owners.

# Table of contents

## Before using the product

Safety precautions	4
Safety symbols	4
Storage	5
Electricity and safety	5
Installation	5
Operation	6
Precautions for use	8

## Preparations

Checking the components	9
Parts	10
Ports	11
Before installing the product (Installation guide)	13
Installing the Wi-Fi module (Model: SI07B)	14
Installing the wall mount	14
Using the wall mount kit	14
Wall mount kit specifications (VESA)	15
Connecting to a network	16
Network settings (Wired)	16
Network settings (Wireless)	18

## Writing

Note - Entry	20
Write	20
UI Elements	21
Write	22
Extension function of the pen	22
Erasing	22
Note Menu	23
Settings	24
Note Functions	25
Palette	30
UI Elements	31

## SETTINGS

System Settings	32
Wireless & Network	33
Wi-Fi	33
Ethernet	34
Hotspot	34
Bluetooth	35
VPN	35
Samba Service	36
Personal	36
Wallpaper	37
Screen Saver	38
Swipe up options at the bottom	38
Multi-Window Mode	39
Input & Output	40
Sound Output Settings	40
Input Naming Settings	41
HDMI OUT Format	41
Application	42
System	43
Date & Time	43
Language & Keyboard	44
Region	44
Storage	45
System Update	46
Eye Protection Mode and Automatic	46
Backlight	46
Pixel Shift	47

---

# Table of contents

Lock Screen	47
Email Account	48
Start up & Shut down	48
Security	50
<hr/>	
<b>Administrator</b>	<b>51</b>
Wake On Lan	52
HDMI CEC	52
USB Clone	52
Default Start up Item	53
Kiosk Mode	53
Auto Remove Files	54
Security lock	54
<hr/>	
<b>About</b>	<b>55</b>
<hr/>	
OSD Menu	55
Home screen	56
Display	56
Audio	57

## Troubleshooting guide

---

Problems and solutions	58
------------------------	----

## Specifications

---

General	64
Preset timing modes	66

## Appendix

---

<b>Responsibility for the pay service (Cost to customers)</b>	<b>67</b>
Not a product defect	67
A product damage caused by customer's fault	67
Others	67
<hr/>	
<b>Prevention of afterimage burn-in</b>	<b>68</b>
What is afterimage burn-in?	68
Recommended prevention practices	68
<hr/>	
<b>HDMI License notice</b>	<b>68</b>
<hr/>	
<b>Low Blue Light</b>	<b>69</b>
<hr/>	
<b>ENERGY STAR</b>	<b>69</b>





# Chapter 01







## Before using the product

### Safety precautions

The following safety instructions are to ensure your personal safety and prevent property damage. Please read the following to ensure the proper use of the product.

### Safety symbols

Symbol	Name	Meaning
	Warning	A serious or fatal injury may result if instructions are not followed.
	Caution	Personal injury or damage to properties may result if instructions are not followed.
	Prohibition	Do NOT attempt.
	Instruction	Follow directions.

CAUTION			
RISK OF ELECTRIC SHOCK. DO NOT OPEN.			
CAUTION: TO REDUCE THE RISK OF ELECTRIC SHOCK, DO NOT REMOVE COVER (OR BACK). THERE ARE NO USER SERVICEABLE PARTS INSIDE. REFER ALL SERVICING TO QUALIFIED PERSONNEL.			
	This symbol indicates that high voltage is present inside. It is dangerous to make any kind of contact with any internal part of this product.		AC voltage: Rated voltage marked with this symbol is AC voltage.
	This symbol indicates that this product has included important literature concerning operation and maintenance.		DC voltage: Rated voltage marked with this symbol is DC voltage.
	Class II product: This symbol indicates that a safety connection to electrical earth (ground) is not required. If this symbol is not present on a product with a mains lead, the product MUST have a reliable connection to protective earth (ground).		Caution. Consult instructions for use: This symbol instructs the user to consult the user manual for further safety related information.

---









## Storage

Due to the characteristics of high-glossy products, using a UV humidifier nearby may create white-colored stains on the product.





 Contact Customer Service Center if the inside of the product needs cleaning (service fee will be charged).

## Electricity and safety

### Warning





-  Do not use a damaged power cord or plug, or a loose power socket.  
An electric shock or fire may result.
-  Do not use multiple products with a single power socket.  
Overheated power sockets may cause a fire.
-  Do not touch the power plug with wet hands. Otherwise, an electric shock may result.
-  Do not bend or pull the power cord with force. Be careful not to leave the power cord under a heavy object.  
Damage to the cord may result in a fire or electric shock.
-  Do not place the power cord or product near heat sources.  
A fire or electric shock may result.
-  Insert the power plug all the way in so it is not loose.  
An unsecure connection may cause a fire.
-  Connect the power plug to a grounded power socket (type 1 insulated devices only).  
An electric shock or injury may result.
-  Clean any dust around the pins of the power plug or the power socket with a dry cloth.  
A fire may result.







### Caution

-  Do not disconnect the power cord while the product is being used.  
The product may become damaged by an electric shock.
-  Only use the power cord provided with your product by Samsung. Do not use the power cord with other products.  
A fire or electric shock may result.
-  Keep the power socket where the power cord is connected unobstructed.  
The power cord must be disconnected to cut off power to the product when an issue occurs.
-  Hold the plug when disconnecting the power cord from the power socket.  
An electric shock or fire may result.





## Installation

### Warning

-  DO NOT PLACE CANDLES, INSECT REPELLANTS OR CIGARETTES ON TOP OF THE PRODUCT. DO NOT INSTALL THE PRODUCT NEAR HEAT SOURCES.  
A fire may result.
-  Do not install the product in poorly ventilated spaces such as a bookcase or closet.  
An increased internal temperature may cause a fire.
-  Do not install the product on an unstable or vibrating surface (insecure shelf, sloped surface, etc.)
  - The product may fall and become damaged and/or cause an injury.
  - Using the product in an area with excess vibration may damage the product or cause a fire.
-  Do not expose the product to direct sunlight, heat, or a hot object such as a stove.  
The product lifespan may be reduced or a fire may result.









-  Do not install the product within the reach of young children.
  - The product may fall and injure children.
  - As the front is heavy, install the product on a flat and stable surface.
-  Edible oil, such as soybean oil, can damage or deform the product. Do not install the product in a kitchen or near a kitchen counter.
-  Have a technician install the wall-mount hanger.
  - Installation by an unqualified person can result in an injury.
  - Only use approved cabinets.
-  Install the product at least 10 cm away from the wall to allow ventilation.  
An increased internal temperature may cause a fire.
-  Keep the plastic packaging out of the reach of children.  
Children may suffocate.
-  Do not install the product in a vehicle or a place exposed to dust, moisture (water drips, etc.), oil, or smoke.  
A fire or electric shock may result.

### Caution

-  Do not set down the product on its front.  
The screen may become damaged.
-  Do not drop the product while moving.  
Product failure or personal injury may result.
-  Set down the product gently.  
Product failure or personal injury may result.
-  Installing the product in an unusual place (a place exposed to a lot of fine dust, chemical substances, extreme temperatures or a significant presence of moisture, or a place where the product will operate continuously for an extended period of time) may seriously affect its performance.  
Be sure to consult Samsung Customer Service Center if you want to install the product at such a place.

## Operation

### Warning

-  There is a high voltage inside the product. Never disassemble, repair or modify the product yourself.
  - A fire or electric shock may result.
  - Contact Samsung Customer Service Center for repairs.
-  Do not let children hang from the product or climb on top of it.  
Children may become injured or seriously harmed.
-  If the product is dropped or the outer case is damaged, turn off the power switch and disconnect the power cord. Then contact Samsung Customer Service Center.  
Continued use can result in a fire or electric shock.
-  Do not leave heavy objects or items that children like (toys, sweets, etc.) on top of the product.  
The product or heavy objects may fall as children try to reach for the toys or sweets resulting in a serious injury.
-  Do not move the product by pulling the power cord or any cable.  
Product failure, an electric shock or fire may result from a damaged cable.
-  Do not lift or move the product by pulling the power cord or any cable.  
Product failure, an electric shock or fire may result from a damaged cable.
-  Ensure the vents are not blocked by tablecloths or curtains.  
An increased internal temperature may cause a fire.
-  Do not insert metallic objects (chopsticks, coins, hairpins, etc) or objects that burn easily (paper, matches, etc) into the product (via the vent or input/output ports, etc).
  - Be sure to power off the product and disconnect the power cord when water or other foreign substances have entered the product. Then contact Samsung Customer Service Center.
  - Product failure, an electric shock or fire may result.

 Do not place objects containing liquid (vases, pots, bottles, etc) or metallic objects on top of the product.

- Be sure to power off the product and disconnect the power cord when water or other foreign substances have entered the product. Then contact Samsung Customer Service Center.
- Product failure, an electric shock or fire may result.

 Before moving the product, turn off the power switch and disconnect the power cable and all other connected cables.

Damage to the cord may result in a fire or electric shock.

 If the product generates abnormal sounds, a burning smell or smoke, disconnect the power cord immediately and contact Samsung Customer Service Center.

An electric shock or fire may result.

 During a lightning or thunderstorm, power off the product and remove the power cable.

A fire or electric shock may result.

 Do not drop objects on the product or apply impact.

A fire or electric shock may result.

 If a gas leakage is found, do not touch the product or power plug. Also, ventilate the area immediately.

Sparks can cause an explosion or fire.

 Do not use or keep combustible spray or an inflammable substance near the product.

An explosion or fire may result.

 **Caution**

 Do not use humidifiers or stoves around the product.

A fire or electric shock may result.

 Do not touch the screen when the product has been turned on for an extended period of time as it will become hot.

 Do not place heavy objects on the product.

Product failure or personal injury may result.

 Leaving the screen fixed on a stationary image for an extended period of time may cause afterimage burn-in or defective pixels.

Activate power-saving mode or a moving-picture screen saver if you will not be using the product for an extended period of time.

 Disconnect the power cord from the power socket if you do not plan on using the product for an extended period of time (vacation, etc).

Dust accumulation combined with heat can cause a fire, electric shock or electric leakage.

 Use the product at the recommended resolution and frequency.

Your eyesight may deteriorate.

 Looking at the screen too close for an extended period of time can deteriorate your eyesight.

 Rest your eyes for more than 5 minutes for every 1 hour of product use.

Eye fatigue will be relieved.

 Store small accessories out of the reach of children.



---

## Precautions for use

Be careful that if you use the supplied pen with a load exceeding 2.5 kg, scratches may occur on the protective glass.

If you use a ballpoint pen other than the supplied pen, be careful that the screen may be stained with ink or damaged.

**Do not use a dirty brush to avoid screen damage.**

-  We recommend that you use the supplied pen. Do not use sharp, pointed objects other than the pen.
-  If dust or dirt from the supplied pen remains on the protective glass, clean it referring to the instructions below.

### Cleaning the exterior and display

Wipe the surface with a slightly wet, soft cloth, and then wipe with a dry cloth.

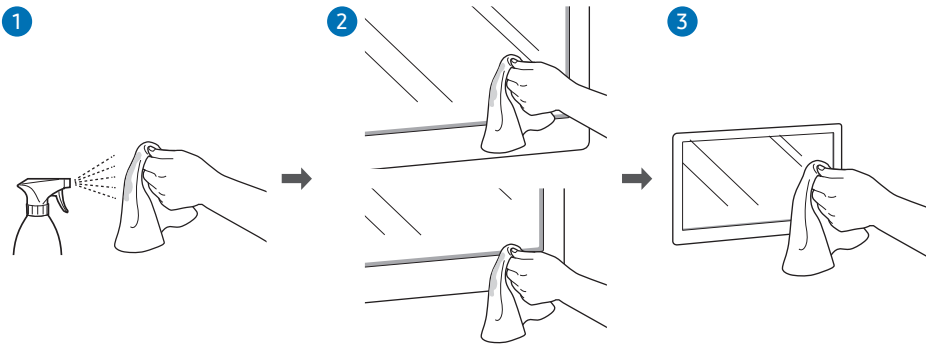



# Chapter 02

## Preparations

### Checking the components

- Contact the vendor where you purchased the product if any components are missing.
- The appearance of the components may differ from the images shown.
- Refer to the installation guide for the WAC stand or wall mount (available for optional purchase).



Quick Setup Guide

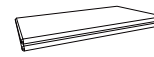

Warranty card  
(Not available in some locations)



Regulatory guide



Waste Electrical & Electronic

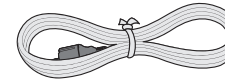

Power cord

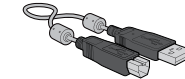

USB cable



Touch pen x 2



HDMI cable

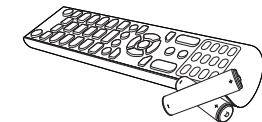

Remote Control  
(batteries x 2 included)

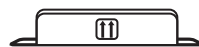

WiFi dongle

# Parts

## WA65C/WA75C/WA86C

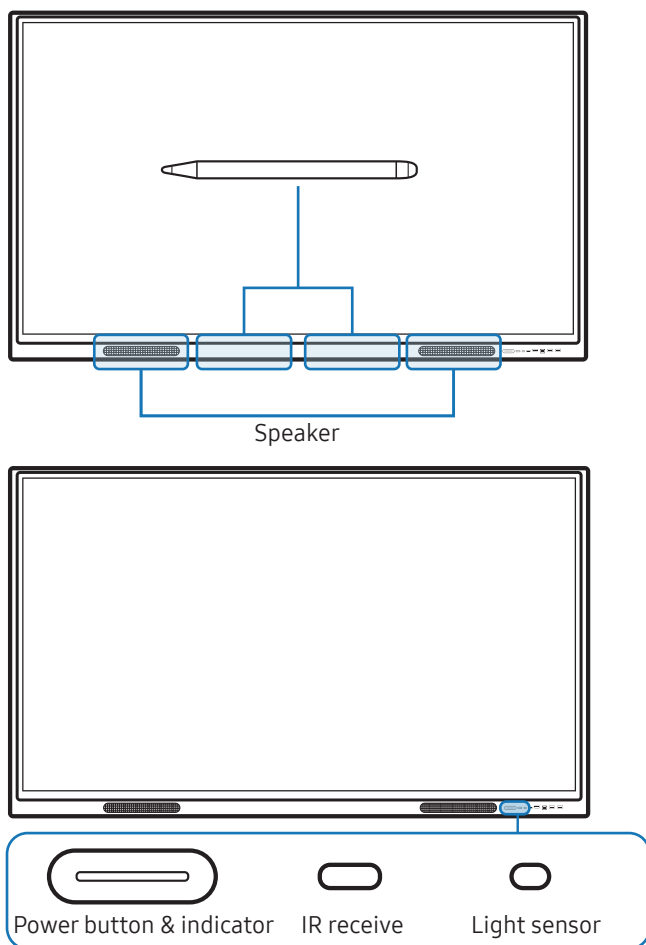

The color and shape of parts may differ from what is shown. Specifications are subject to change without notice to improve quality.

Parts	Description
Speaker	Speaker output
	The pen is magnetic. Keep it by attaching to the marked location.
Power button & indicator	<p>Press the button to turn on the product and press and hold the button to turn off the product.</p> <ul style="list-style-type: none"> <li> The power indicator turns white when the product is turned on.</li> <li> The power indicator turns red when the product is turned off.</li> </ul> <p>In writing mode, lightly press the <b>Power</b> button to switch to the screen saver mode.</p> <p>In case the PIP screen is in <b>Full Screen</b> mode, press the <b>Power</b> button to display the adjustment menu. Press again to hide.</p>
Light sensor	<p>The light sensor is used to detect ambient light for the <b>Brightness Optimisation</b> function.</p> <ul style="list-style-type: none"> <li>You can turn on or off the <b>Brightness optimization</b> function at <b>Menu</b> → <b>SETTINGS</b> → <b>System</b> → <b>Advanced Settings</b> → <b>Brightness Optimisation</b>.</li> </ul>
IR receive	Remote infrared receiver
OPS case (Sold separately)	<p>Connect the OPS case to the product and insert the standard OPS module into the case. You can purchase the OPS case and module separately.</p> <ul style="list-style-type: none"> <li> Before inserting the OPS module, make sure to remove the power cable from the product to completely cut off the power supply.</li> <li> OPS refers to the Intel Open Pluggable Specification.</li> <li> OPS power supply: 18V/3.5A</li> </ul>

# Ports

## WA65C/WA75C/WA86C

### Front

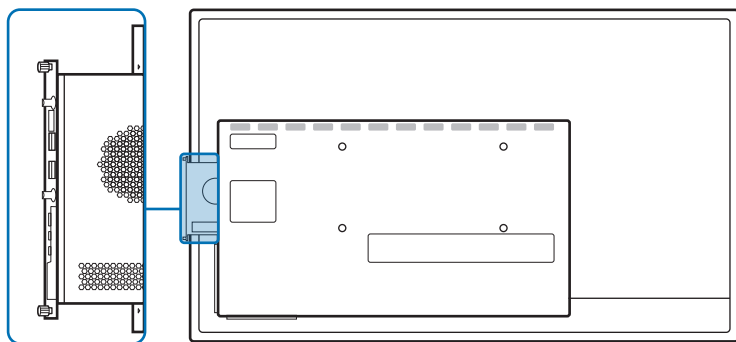
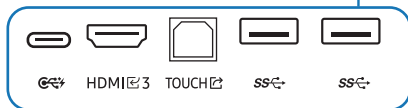

*The color and shape of parts may differ from what is shown. Specifications are subject to change without notice to improve quality.*

Ports	Description
	<p>You can connect a device using a USB-C cable.</p> <ul style="list-style-type: none"> <li>• USB-C connection allows video output and touch-based control of the device.</li> </ul> <p><i>You must use a USB-C cable with DP ALT Mode support for video transmission.</i></p> <p><i>Use a USB-C cable that is 1 m or shorter in length.</i></p> <p><i>Charging is supported up to 65 W. Charging with USB-C cable is only available when the product is on.</i></p>
HDMI 3	An HDMI port for displaying input from an external source.
TOUCH	<p>Allows touch-based control of the PC screen connected through the HDMI3 port </p> <p>Use the supplied USB cable to connect between the TOUCH </p>
	<p>Connect to a USB memory device.</p> <p><i>The USB ports on the product provide a maximum constant current of 1.0 A. If the maximum value is exceeded, USB ports may not work.</i></p>
	<p>Connect to a USB memory device.</p> <p><i>The USB ports on the product provide a maximum constant current of 1.0 A. If the maximum value is exceeded, USB ports may not work.</i></p>

# WA65C/WA75C/WA86C

## Rear

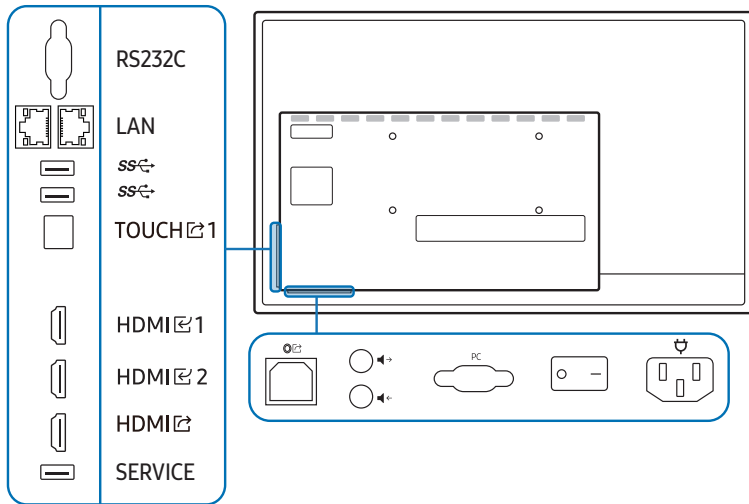

The color and shape of parts may differ from what is shown. Specifications are subject to change without notice to improve quality.

Ports	Description
RS232C	Serial Interface for debug only.
LAN	Connects to a network using a LAN cable. (1000 Mbps) Below port: Connect RJ45 output terminal Above port: Connect RJ45 input terminal
	Connect to a USB memory device. The USB ports on the product accept a maximum constant current of 1.0 A. If the maximum value is exceeded, USB ports may not work.
	Connect to a USB memory device. The USB ports on the product accept a maximum constant current of 1.0 A. If the maximum value is exceeded, USB ports may not work.
TOUCH (  ) 1	Allows touch-based control of the PC screen connected through the <b>HDMI1</b> port. Use the supplied USB cable to connect between the TOUCH port on the rear of the product and the PC.
HDMI (  ) 1	Connects to a source device using a HDMI cable.
HDMI (  ) 2	Connects to a source device using a HDMI cable.
HDMI	Connects to a sink device using a HDMI cable.
SERVICE	Used for updating OS Firmware
	Optical audio port for multichannel audio.
	Audio output to the external speaker.
	Microphone audio input.
PC	VGA input port.
	Power interface

## Before installing the product (Installation guide)

This product can be wall-mounted. The wall mount are available for optional purchase.

### WA65C/WA75C/WA86C

#### Ventilation

 Contact Samsung Customer Service Center for further details.

#### Installation on a perpendicular wall

- A Minimum 30 mm
- B Ambient temperature: 35 °C or less

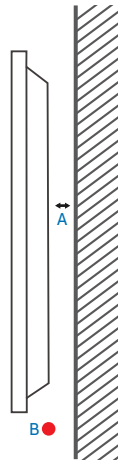

#### Installation on an indented wall

- A Minimum 30 mm
  - B Minimum 25 mm
  - C Ambient temperature: 35 °C or less
-  When installing the product on an indented wall, allow at least the space specified above between the product and wall for ventilation and ensure that the ambient temperature is kept below 35 °C.

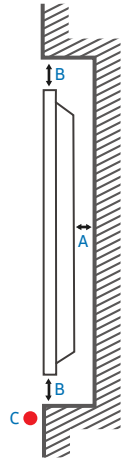

## Installing the Wi-Fi dongle (Model: SI07B)

**Warning:** Disconnect the product's power cord before the installation.

- 1 Remove the Wi-Fi slot's cover.

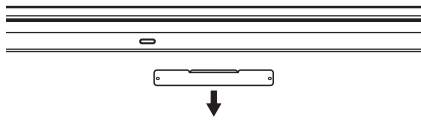

- 2 Fully insert the Wi-Fi dongle into the slot.

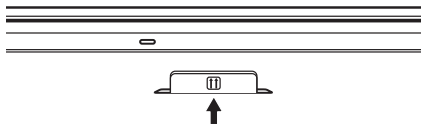

- The Wi-Fi dongle only works when it is properly inserted into the designated slot in the product.

## Installing the wall mount

 This product can be wall-mounted. The wall mount are available for optional purchase.

### Using the wall mount kit

- The wall mount kit allows you to mount the product on the wall.
- For detailed information on installing the wall mount, see the instructions provided with the wall mount.
- We recommend you contact a technician for assistance when installing the wall mount bracket.
- Samsung is not responsible for any damage to the product or injury to yourself or others if you select to install the wall mount on your own.

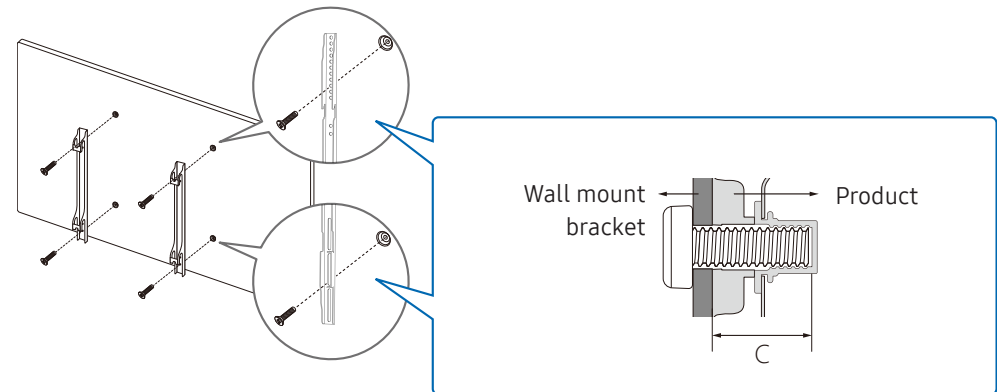

## Wall mount kit specifications (VESA)

 Install your wall mount on a solid wall perpendicular to the floor. To install the product on the other wall area, contact the nearest agency. If you install the product on a slanted wall, it may fall and result in severe personal injury.

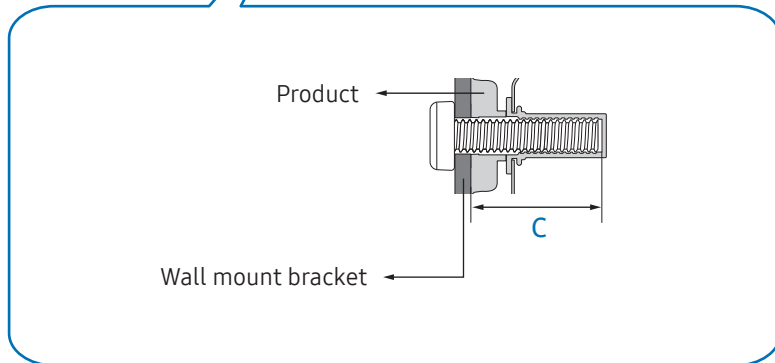
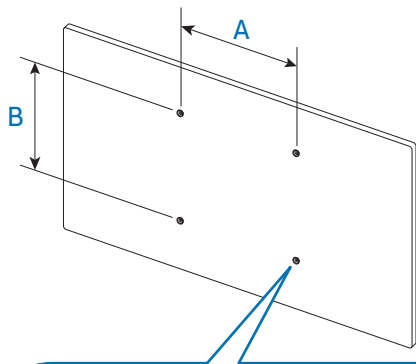

- Samsung wall mount kits contain a detailed installation manual and all parts necessary for assembly are provided.
- Do not use screws that are longer than the standard length or do not comply with the VESA standard screw specifications. Screws that are too long may cause damage to the inside of the product.
- For wall mounts that do not comply with the VESA standard screw specifications, the length of the screws may differ depending on the wall mount specifications.
- Do not fasten the screws too firmly. This may damage the product or cause the product to fall, leading to personal injury. Samsung is not liable for these kinds of accidents.
- Samsung is not liable for product damage or personal injury when a non-VESA or non-specified wall mount is used or the consumer fails to follow the product installation instructions.
- Always have at least two people mount the product on a wall.
- Standard dimensions for wall mount kits are shown in the table below.

Model name	VESA screw hole specs (A x B) in millimetres	C (mm)	Standard screw	Quantity
WA65C	600 x 400	28.3 - 30.3	M8	4
WA75C	800 x 400	28.3 - 30.3		
WA86C	800 x 600	28.3 - 30.3		

 Do not install your Wall Mount Kit while your product is turned on. It may result in personal injury due to electric shock.

# Connecting to a network

 Connecting parts may differ in different products.

## Network settings (Wired)

### Connecting to a wired network

There are three ways to attach your product to your LAN using cable.

- You can attach your product to your LAN by connecting the LAN port on the back of your product to an external modem using a LAN cable. See the diagram below.

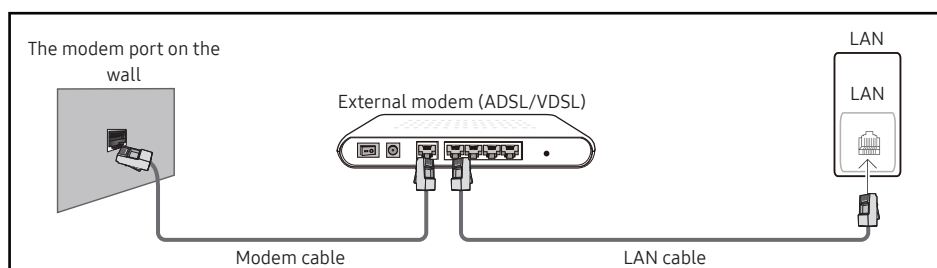

- You can attach your product to your LAN by connecting the LAN port on the back of your product to an IP sharer which is connected to an external modem. Use LAN cable for the connection. See the diagram below.

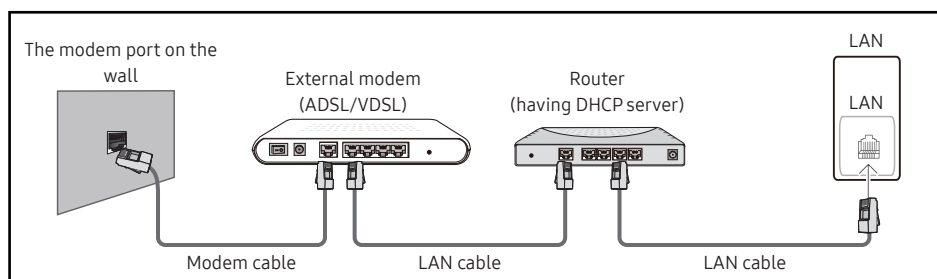

- Depending on how your network is configured, you may be able to attach your product to your LAN by connecting the LAN port on the back of your product directly to a network wall outlet using a LAN cable.

See the diagram below. Note that the wall outlet is attached to a modem or router elsewhere in your house.

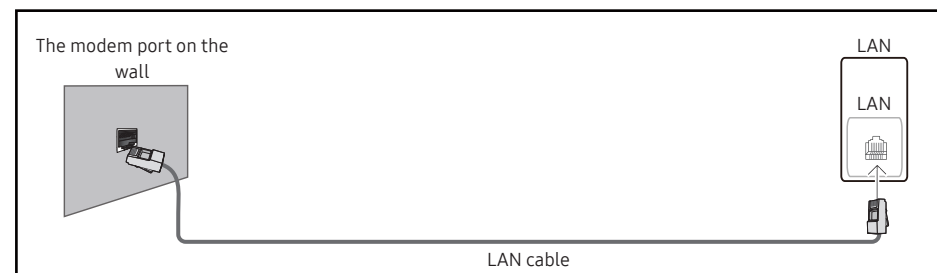

If you have a Dynamic Network, you should use an ADSL modem or router that supports the Dynamic Host Configuration Protocol (DHCP). Modems and routers that support DHCP automatically provide the IP address, subnet mask, gateway, and DNS values your product needs to access the Internet so you do not have to enter them manually. Most home networks are Dynamic Networks.

Some networks require a Static IP address. If your network requires a Static IP address, you must enter the IP address, subnet mask, gateway, and DNS values manually on your product Cable Setup Screen when you set up the network connection. To get the IP address, subnet mask, gateway, and DNS values, contact your Internet Service Provider (ISP).

If you have a Windows computer, you can also get these values through your computer.

 You can use ADSL modems that support DHCP if your network requires a Static IP address.

 ADSL modems that support DHCP also let you use Static IP addresses.



---



Set the network connection to use Internet services such as perform software upgrades.

## Automatic Open Network Settings (Wired)

Connect to the network using a LAN cable.

Make sure a LAN cable is connected first.

### How to set up automatically

- 1 Set **Network Type** to **Wired** from the **Open Network Settings** page.
  - 2 The network connection screen appears, and the verification process starts.
  - 3 When the connection has been verified, the **OK** button appears on the bottom of the screen.
  - 4 Tap **OK**.
-  If the connection process fails, check the LAN port connection.
-  If the automatic process cannot find the network connection values or if you want to set the connection manually, go to the next section, "[Manual Open Network Settings \(Wired\)](#)".

## Manual Open Network Settings (Wired)

Offices may use static IP addresses.

If this is the case, ask the network administrator for the IP address, subnet mask, gateway and DNS server address. Enter these values manually.

### Getting the network connection values

To view the Network connection values on most Windows computers, follow these steps.

- 1 Right click the **Network** icon on the bottom right of the screen.
- 2 In the pop-up menu that appears, click **Status**.
- 3 On the dialog that appears, click the **Support** tab.
- 4 On the **Support** tab, click the **Details** button. The Network connection values are displayed.

### How to set up manually

- 1 Set **Network Type** to **Wired** from the **Open Network Settings** page.
- 2 The network connection screen appears, and the verification process starts.
- 3 Select **Cancel** while network connections are being attempted. This will stop the connection.
- 4 Select **IP Settings** on network connection screen. The **IP Settings** screen appears.
- 5 Select the field at the top and then set **IP setting** to **Enter manually**.  
 Setting **IP setting** to **Enter manually** automatically changes **DNS setting** to **Enter manually**.
- 6 Enter the **IP Address**, **Subnet mask**, **Gateway**, and **DNS Server** values manually.
- 7 When done, select **OK** at the bottom of the page. The network test screen appears and the verification process starts.
- 8 When the connection has been verified, the **OK** button appears on the bottom of the screen.
- 9 Tap **OK** to complete the setting.

## Network settings (Wireless)

### Connecting to a wireless network

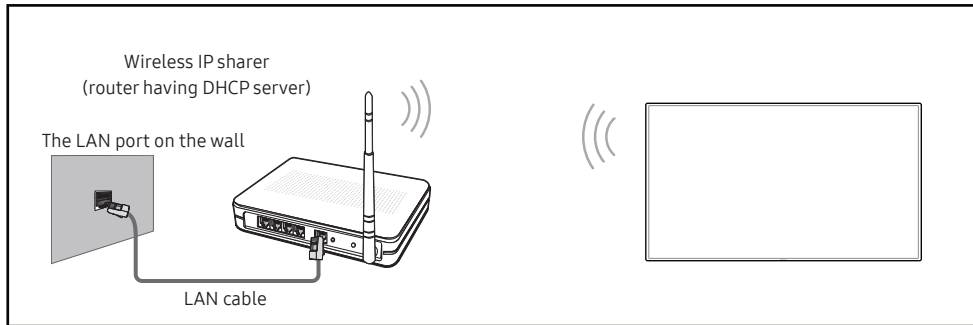

Samsung recommends using IEEE 802.11n. When you play video over a network connection, the video may not play smoothly.

- ✎ Select a channel for the wireless IP sharer that is not currently being used. If the channel set for the wireless IP sharer is currently being used by another device nearby, this will result in interference and communication failure.
- ✎ Your product supports only the following wireless network security protocols. If you select the Pure High-throughput (Greenfield) 802.11n mode and the encryption type is set to WEP, TKIP or TKIP AES (WPS2Mixed) on your AP or wireless router, Samsung products will not support a connection in compliance with new Wi-Fi certification specifications.
- ✎ If your wireless router supports WPS (Wi-Fi Protected Setup), you can connect to the network via PBC (Push Button Configuration) or PIN (Personal Identification Number). WPS will automatically configure the SSID and WPA key in either mode.
- ✎ Connection methods: You can setup the wireless network connection in three ways. Auto Setup (Using the Auto Network Search function), Manual Setup, Use WPS
- ✎ This product supports Enterprise WPA2 (TLS/TLS/PEAP).

### Automatic network setup (Wireless)

Most wireless networks have an optional security system that requires devices that access the network to transmit an encrypted security code called an Access or Security Key. The Security Key is based on a Pass Phrase, typically a word or a series of letters and numbers of a specified length you were asked to enter when you set up security for your wireless network. If you use this method of setting up the network connection, and have a Security Key for your wireless network, you will have to enter the Pass Phrase during the automatic or manual setup process.

#### How to set up automatically

- 1 Set **Network Type** to **Wireless** from the **Open Network Settings** page.
- 2 The product searches for available wireless networks. When done, it displays a list of the available networks.
- 3 In the list of networks, select a network.
  - ✎ If the desired wireless router does not appear, select **Refresh** to search again.
  - ✎ If the router cannot be found after retrying, select **Add Network**.
- 4 If you selected a password-protected network, enter the password, and tap **Go**.
  - ✎ You may skip this step if you selected an open network.
- 5 The network connection screen appears, and the verification process starts.
- 6 When the connection has been verified, the **OK** button appears on the bottom of the screen.
- 7 Tap **OK**.

### Manual network setup (Wireless)

Offices may use static IP addresses.





If this is the case, ask the network administrator for the IP address, subnet mask, gateway and DNS server address. Enter these values manually.

#### Getting the network connection values

To view the network connection values on most Windows computers, follow these steps.

- 
- 1 Right click the **Network** icon on the bottom right of the screen.
  - 2 In the pop-up menu that appears, click **Status**.
  - 3 On the dialog that appears, click the **Support** tab.
  - 4 On the **Support** tab, click the **Details** button. The Network connection values are displayed.

### How to set up manually

- 1 Set **Network Type** to **Wireless** from the **Open Network Settings** page.
- 2 The product searches for available wireless networks. When done, it displays a list of the available networks.
- 3 In the list of networks, select a network.
  -  If the desired wireless router does not appear, select **Refresh** to search again.
  -  If the router cannot be found after retrying, select **Add Network**.
- 4 If you selected a password-protected network, enter the password, and tap **Go**.
  -  You may skip this step if you selected an open network.
- 5 The network connection screen appears, and the verification process starts.
- 6 Select **Cancel** while network connections are being attempted. This will stop the connection.
- 7 Select **IP Settings** on network connection screen. The **IP Settings** screen appears.
- 8 Select the field at the top and then set **IP setting** to **Enter manually**.
  -  Changing **IP setting** to **Enter manually** automatically changes **DNS setting** to **Enter manually**.
- 9 Enter the **IP Address**, **Subnet mask**, **Gateway**, and **DNS Server** values manually.
- 10 When done, select **OK** at the bottom of the page. The network test screen appears, and the verification process starts.
- 11 When the connection has been verified, the **OK** button appears on the bottom of the screen.
- 12 Tap **OK** to complete the setting.

### How to set up using the WPS button

If your router has a WPS button, follow these steps.

- 1 Set **Network Type** to **Wireless** from the **Open Network Settings** page.
- 2 Select **Use WPS**.
- 3 Press the WPS or PBC button on your wireless router within the next two minutes. Your product automatically acquires all the network setting values it needs and connects to your network.
- 4 The network connection screen appears, and network setup is done.

# Chapter 03

## Writing

### Note - Entry

Tap **All Apps** > **Note** on the sidebar or tap the shortcut widget on the home screen to open the Note app.

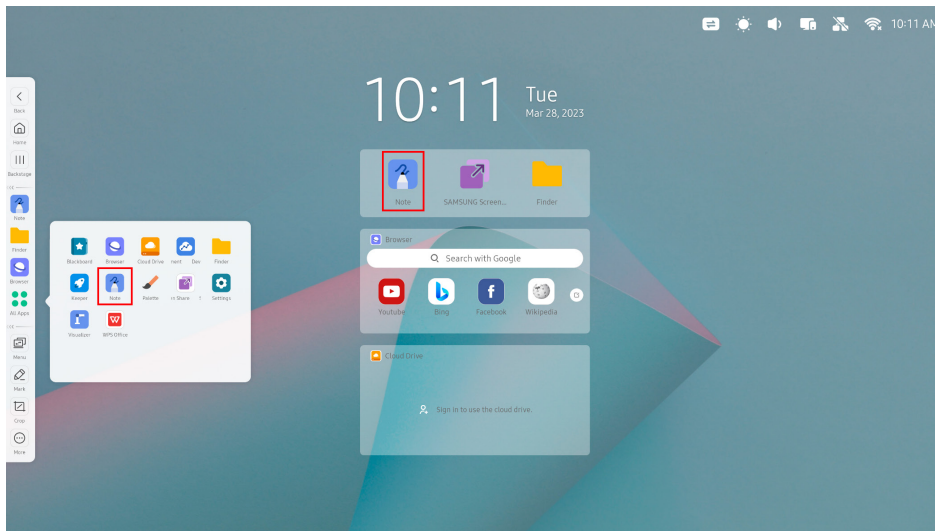

### Write

Note features various brush types and allows you to select the color and adjust the thickness of the brush.

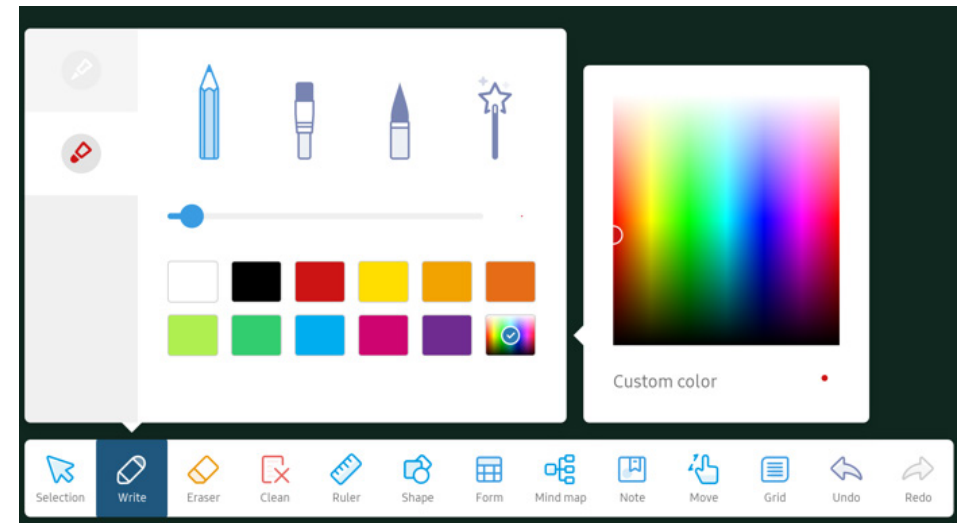

## UI Elements

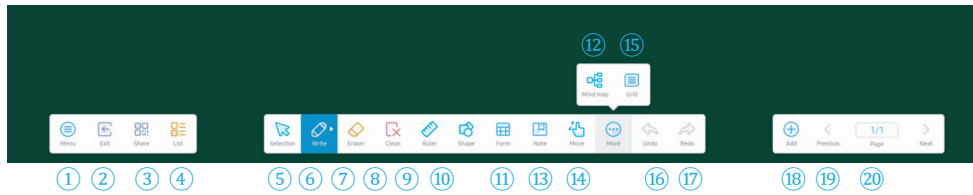

Buttons	Description
1 <b>Menu</b>	<ul style="list-style-type: none"> <li>Perform general operations on Note, such as adding, opening, saving, importing, or exporting a note. You can also upload a note to the cloud storage, specify the canvas background, send a note via email, and configure global settings.</li> </ul>
2 <b>Exit</b>	Exit the Note app.
3 <b>Share</b>	Share the Note page via the QR code.
4 <b>List</b>	Open the Note canvas list.
5 <b>Selection</b>	Select the content written on or inserted into a canvas.
6 <b>Write</b>	Tap Write and tap it again to open the brush settings. You can select the brush type, color, and thickness.
7 <b>Eraser</b>	Tap Eraser and tap it again to specify the eraser size.
8 <b>Clean</b>	Tap Clean to clean the current canvas content.
9 <b>Ruler</b>	Insert a ruler into a canvas. The ruler can be a straight ruler, a triangular ruler, or a protractor.
10 <b>Shape</b>	Insert a 2D or 3D shape into a canvas.
11 <b>Form</b>	Insert a form into a canvas and specify the numbers of rows and columns of the form.
12 <b>Mind map</b>	Insert a mind map into a canvas. You can edit the mind map at any time.
13 <b>Note</b>	Insert a note into a canvas.

Buttons	Description
14 <b>Move</b>	Zoom a canvas to move within it by using the <b>Move</b> option.
15 <b>Grid</b>	Insert a grid into a canvas.
16 <b>Undo</b>	Undo the current operation.
17 <b>Redo</b>	Redo the undone operation.
18 <b>Add</b>	Tap this button to add a page to the Note note.
19 <b>Previous/Next</b>	Tap this button to go to the previous or next page.
20 <b>Page</b>	Tap this button to open the page management page on which you can see all pages.

## Write

Use the supplied pen to write on the display.

- Thin tip (A): Pen type
- Thick tip (B): Highlighter type

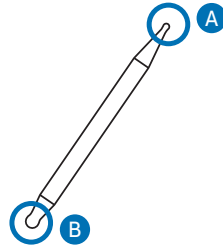

## Extension function of the pen

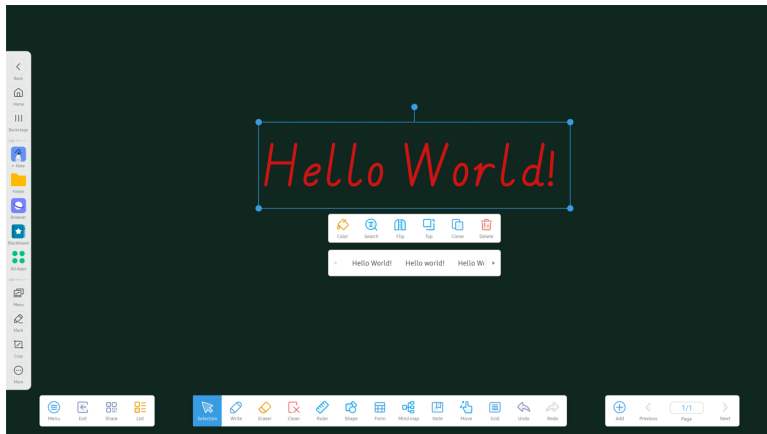

After writing, you can select the handwriting by using the selection tool and use the SmartWrite tool to quickly convert the content into calligraphic fonts.

## Erasing

Select **Eraser** to erase the written content with either end of the pen or your finger. You can use your palm to erase the content in a large area on the screen. You can also tap **Clean** to quickly clear all content written on the current screen.

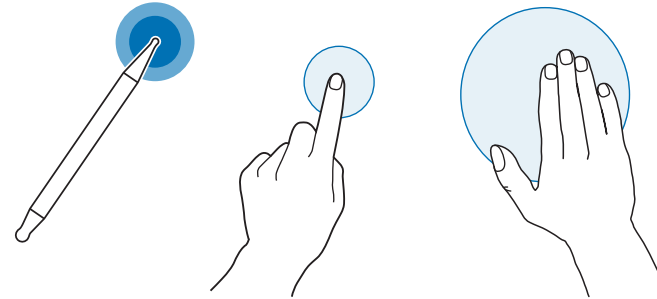

Tap **Eraser** and tap it again to set the eraser size.

You can also select **Eraser mode** in **Settings**. If you select **Erase selection**, the selection-based eraser mode applies. In this mode, any selected content is erased.

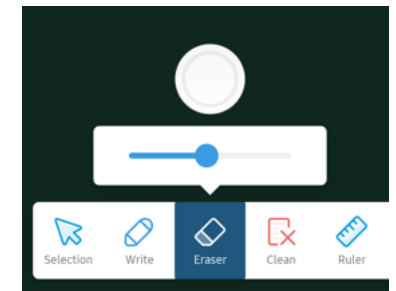

## Note Menu

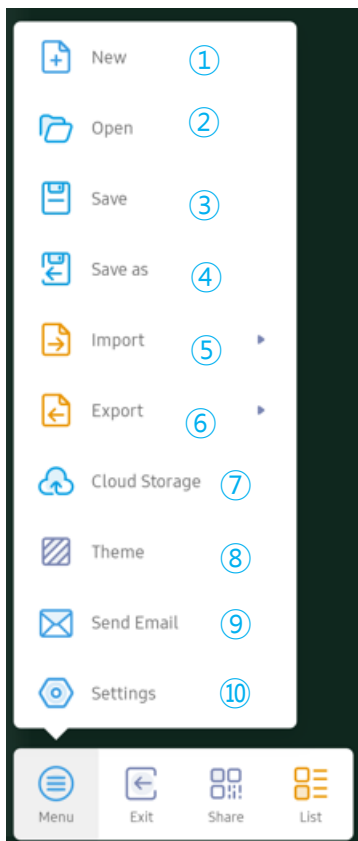

Item	Description
1 <b>New</b>	Create a note.
2 <b>Open</b>	Open an existing note.
3 <b>Save</b>	Save the current note.
4 <b>Save as</b>	Save the current note in the desired format.
5 <b>Import</b>	Import a note in the IMG, PDF, SVG, or IWB format.
6 <b>Export</b>	Export a note in the IMG, PDF, SVG, or IWB format.
7 <b>Cloud Storage</b>	Upload a note to cloud storage.
8 <b>Theme</b>	Specify the background theme of the canvas. A color or preset template is supported.
9 <b>Send Email</b>	Send the current note via email.
10 <b>Settings</b>	Apply the global settings of Note.

# Settings

**Eraser mode**

Eraser  Erase selection

**Multi-finger writing**

Multi-finger writing is allowed when turned on, and multi-finger is preview when turned off.

**Automatic brightness**

When enabled, automatically adjust the display brightness when writing.

**Custom toolbars** >

Select the tools that appear in the toolbar when Note is full screen, unselected tools will be move to More button.

**Handwriting recognition language** >

Item	Description
1 Eraser mode	Set Eraser mode to Eraser or Erase selection.
2 Multi-finger writing	Swiping with multiple fingers allows you to write by using multiple fingers when this option is toggled on or drag the canvas when this option is toggled off.
3 Automatic brightness	When this option is toggled on, the screen automatically dims when you write or erase a content and brightens after the action is done.
4 Custom toolbars	Customize the Note toolbars based on your requirements.
5 Handwriting recognition language	Specify the handwriting recognition language.



## Note Functions

### QR code-based sharing

Scan to share and read.



Click to enlarge QR Code



Tap the QR code to enlarge it.



## Note canvas list

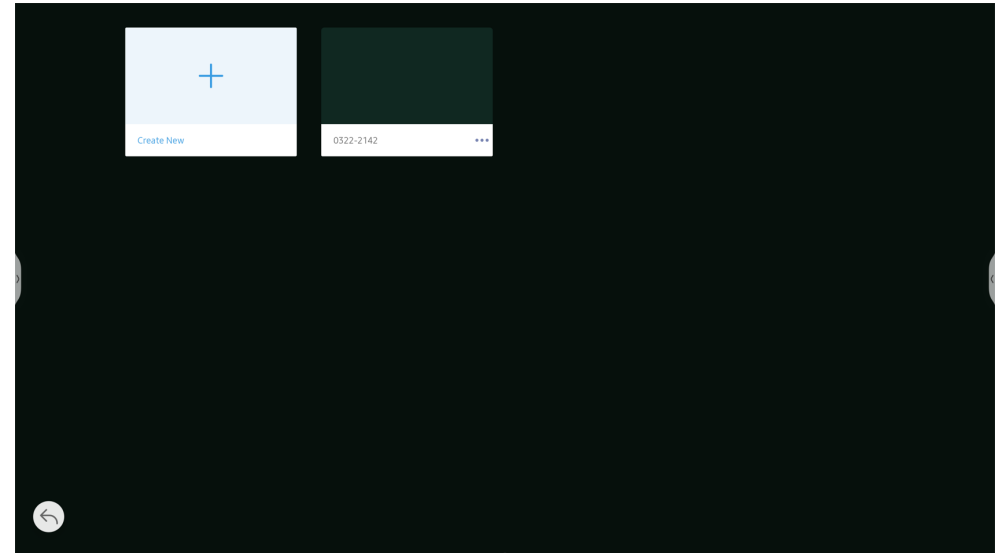

## Brush settings

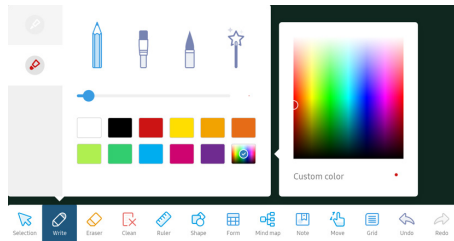

Adjust the eraser size.

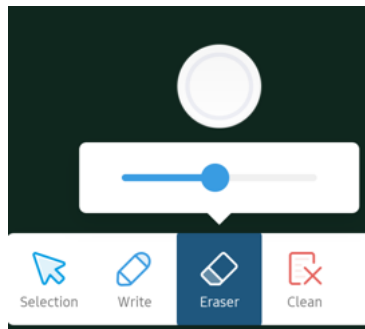

## Ruler

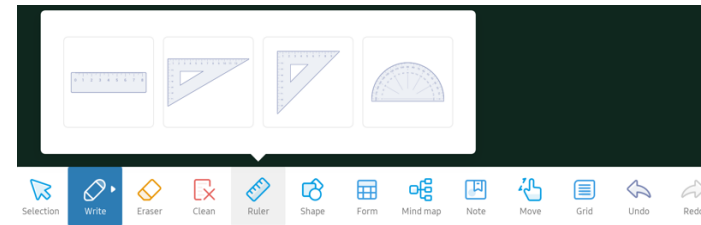

Select ruler type to use.

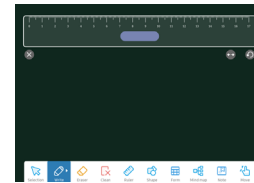

Selected ruler is activated for use.

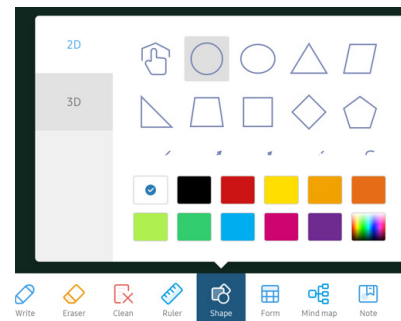

You can insert a 3D shape and preset its color.

## Form

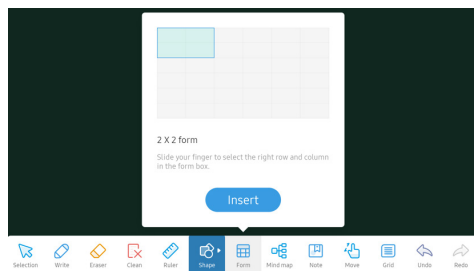

A form is inserted as shown.

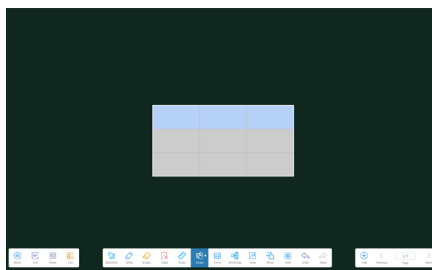

The cells in the form automatically adapt to the handwriting size.

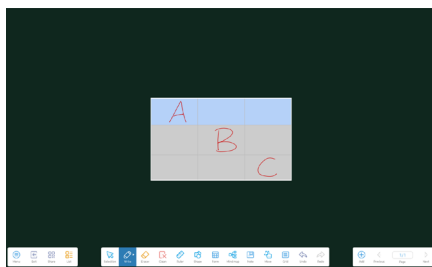

## Mind map

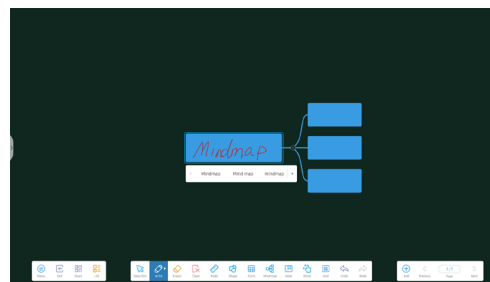

The system automatically recognizes handwriting and generates candidate text.

After a candidate text is selected, the handwriting is automatically beautified.

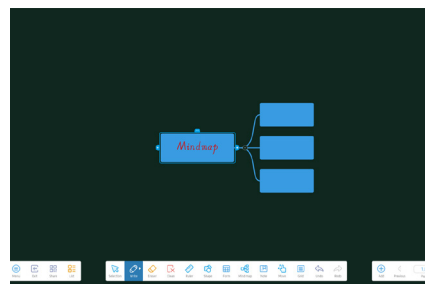

Write outside of a canvas (available after the zoom scale exceeds 100%).

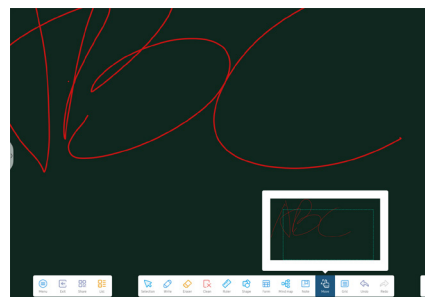

## Note



A note is inserted as shown, which automatically appears in the top right corner.

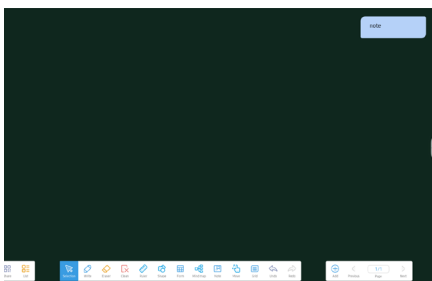

Grid

The system automatically recognizes the handwriting in the grid, generates candidate text, and converts the handwriting into standard fonts after a candidate text is selected.

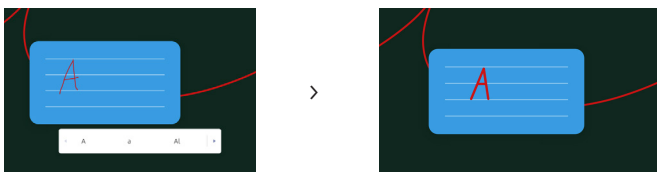

Selection: Different functions are available for different content. Below are examples.

Shape: After selecting a shape, you can change the frame/fill color of the shape and flip, pin to top, clone, or delete it.

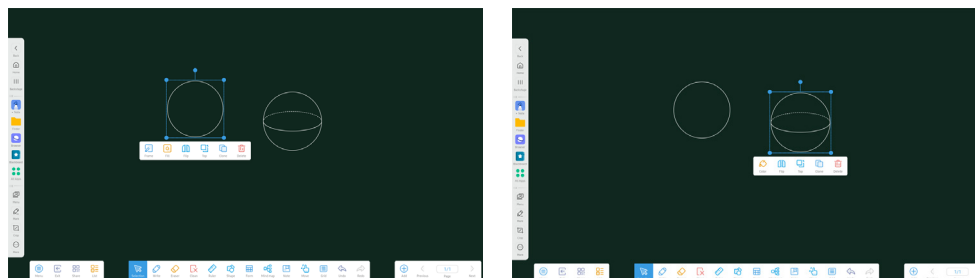

Form: After selecting a form, you can pin to top or delete the form.

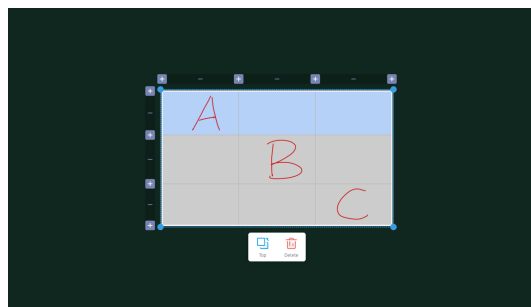

Mind map: After selecting a mind map, you can change the color or text color of the mind map and pin to top, clone, or delete it.

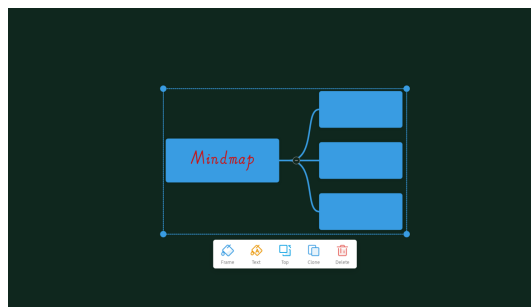

## Page

Tap **Page** to view, select, or delete all pages that are added to the note.

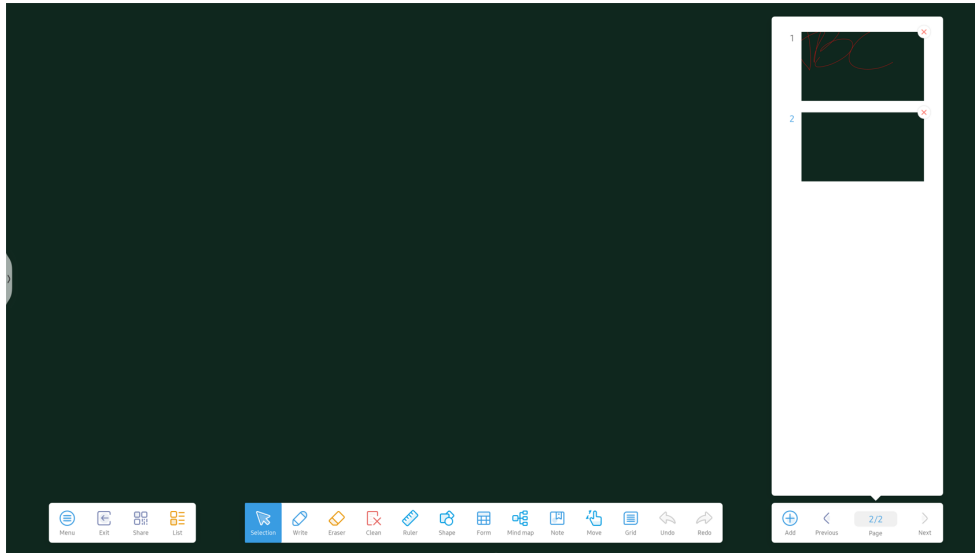

## Exit

Tap **Exit**. You are prompted whether to save the note. You can save the note and exit or exit directly.

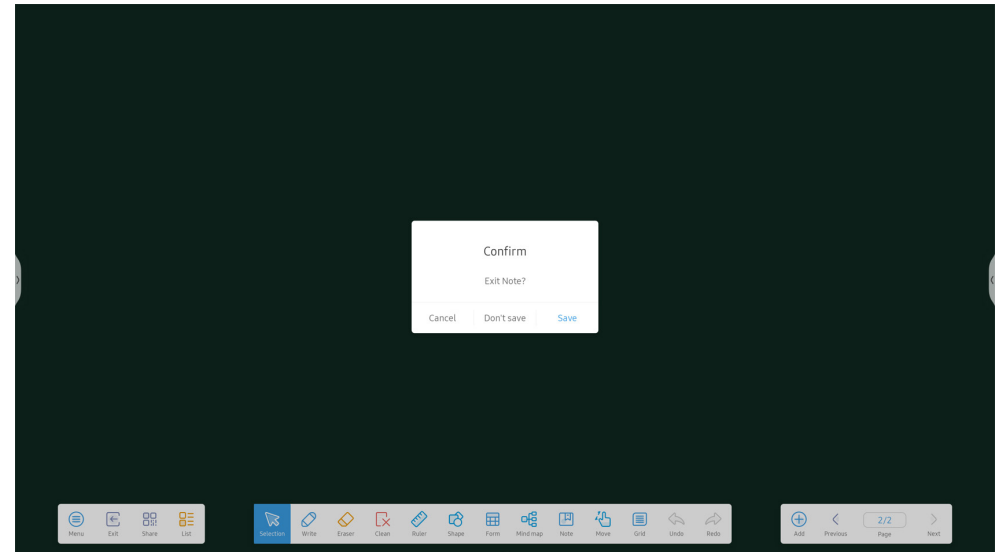

# Palette

Home screen: By default, the **ToolBox** and **ColorBox** options are displayed in the palette for quick selection.

Entry: **All Apps > Palette**.

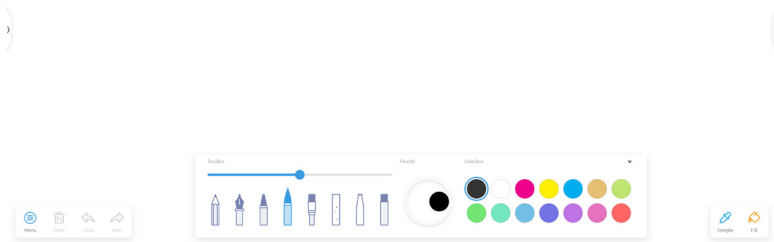
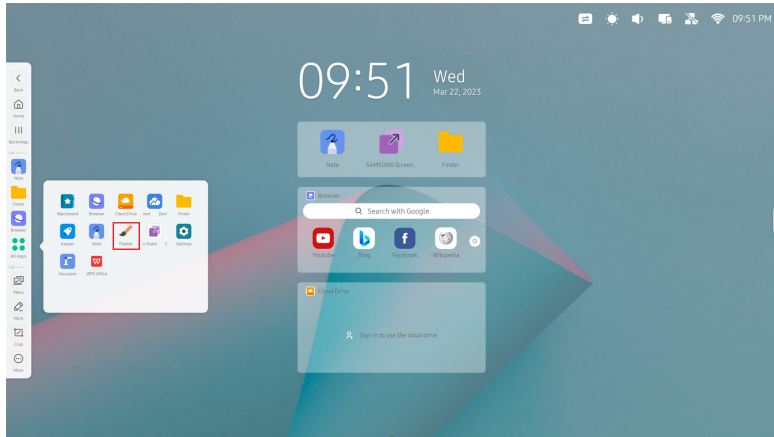

## UI Elements

The palette allows you to explore and use more artistic functions in your creation.

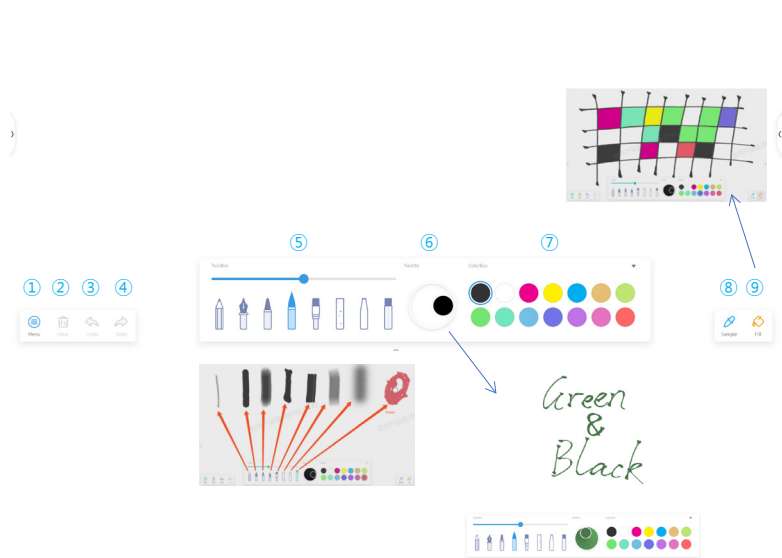

Item	Description
1 <b>Menu</b>	The menu allows you to perform operations such as saving, importing, sharing, and exiting.
2 <b>Clear</b>	Tap to clear a canvas.
3 <b>Undo</b>	Undo the current operation.
4 <b>Redo</b>	Redo the undone operation.
5 <b>ToolBox</b>	Seven brushes and one eraser (rightmost) are available. You can specify the brush thickness and eraser size.
6 <b>Palette</b>	Mix colors to get a unique color for your brush: Step 1. Select a color from <b>ColorBox</b> . Step 2. Drag the wheel in the palette. The palette turns into the corresponding color. Step 3. Select another color from <b>ColorBox</b> . Step 4. Drag the wheel in the palette again to mix the two colors. 
7 <b>ColorBox</b>	Select the desired color for drawing or mixing from <b>ColorBox</b> .
8 <b>Sample</b>	Pick a color at any position on the current page for your brush.
9 <b>Fill</b>	Fill any enclosed area on a canvas with a specified color.

# Chapter 04

## SETTINGS

### System Settings

You can tailor system settings to your habits.

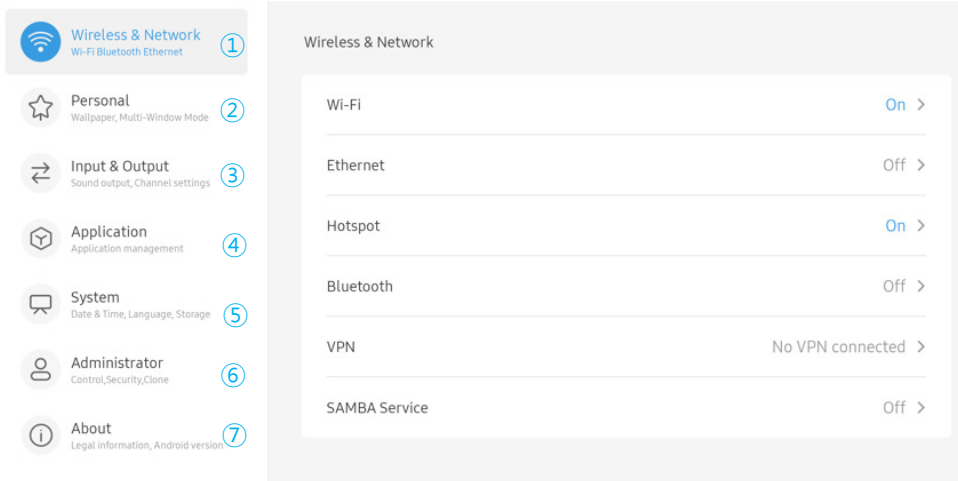

Item	Description
1 <b>Wireless &amp; Network</b>	Set up the system network connection.
2 <b>Personal</b>	Apply personal settings.
3 <b>Input &amp; Output</b>	Set the audio or video input and output of the system.
4 <b>Application</b>	Browse and manage apps on the device.
5 <b>System</b>	Apply general system settings.
6 <b>Administrator</b>	Apply administrator settings.
7 <b>About</b>	View system and legal information.



# Wireless & Network

## Wi-Fi

When a Wi-Fi dongle is inserted, you can browse the list of available Wi-Fi networks and select one to establish the connection.

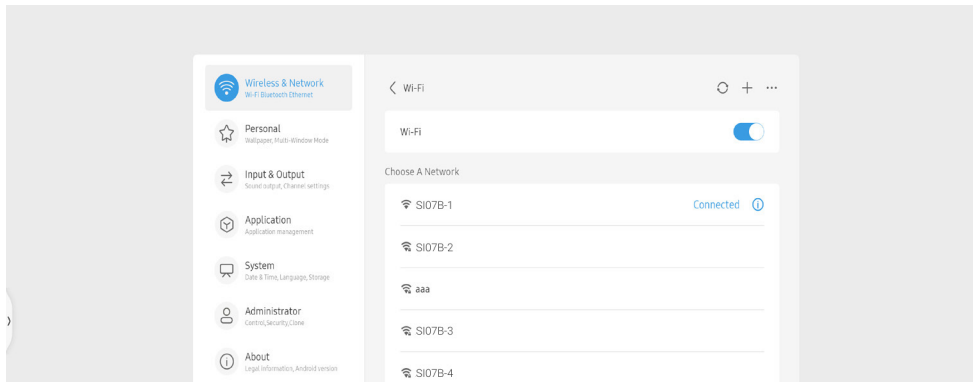

Tap a connected Wi-Fi network to view the details:

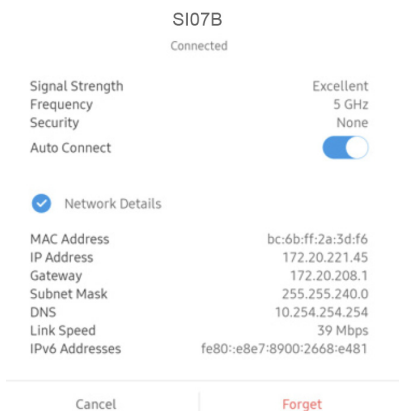

You can also tap the “+” icon in the top right corner to add and connect to a hidden network.

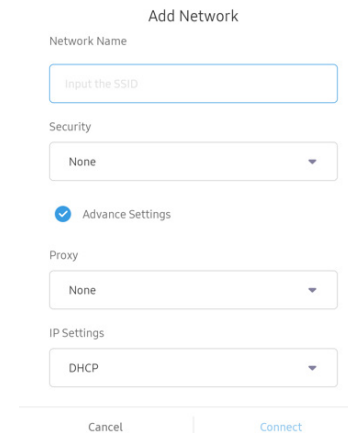

Tap the “...” icon in the top right corner to open **Wi-Fi Preferences**.

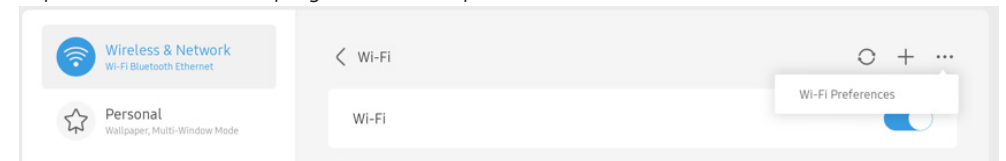

In **Wi-Fi Preferences**, check the MAC address and IP address of the device and install credentials.

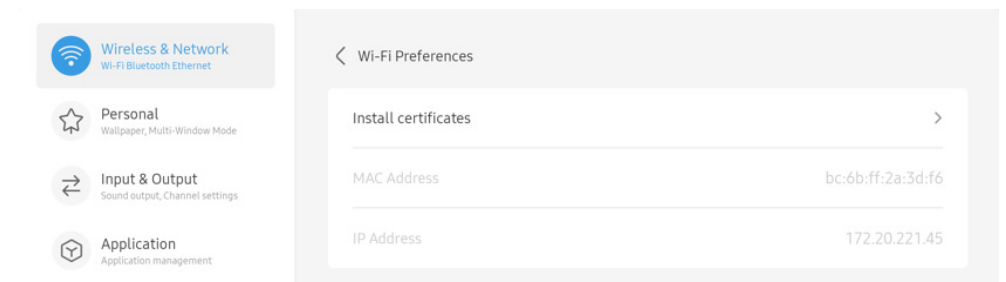

## Ethernet

If a network cable is connected, you can configure the network in the **Ethernet** option.

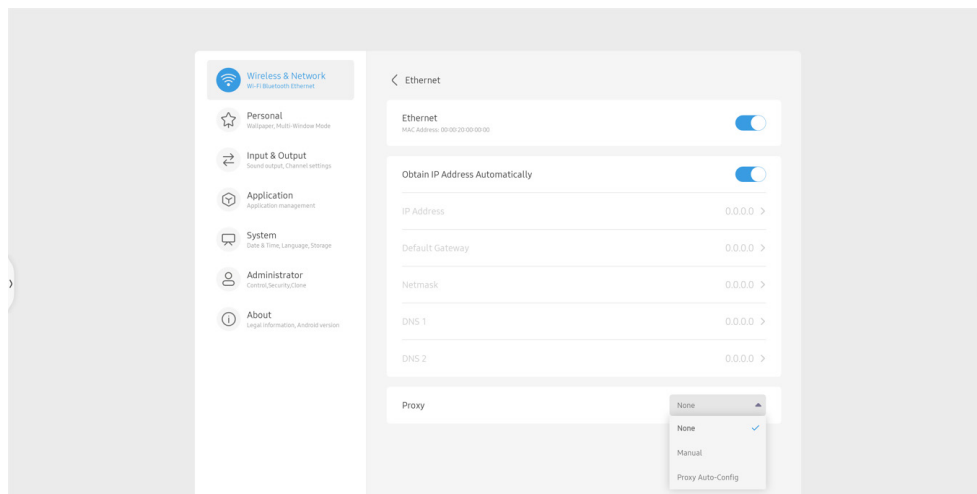

You can select automatic or manual configuration. In automatic configuration, the system automatically obtains the IP address and other information about the Ethernet and establishes the connection. In manual configuration, you need to manually enter the corresponding information.

You can also configure an Ethernet proxy for proxy-based access.

## Hotspot

If a Wi-Fi dongle with the hotspot function is inserted, you can specify a hotspot name and a password to control device access.

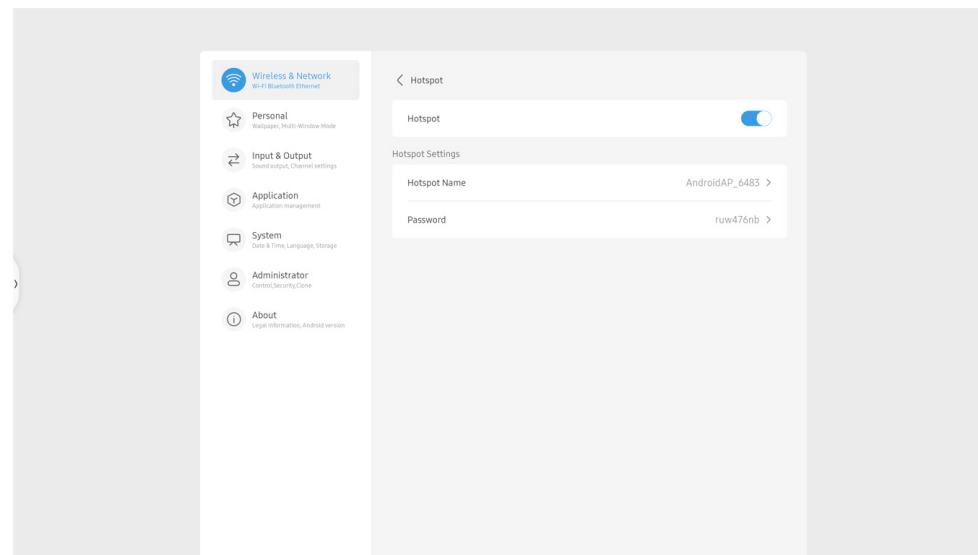

Item	Description
<b>Hotspot Name</b>	Specify a hotspot name.
<b>Security</b>	Specify the encryption method of the hotspot, for example, WPA or WPA2-PSK.
<b>Password</b>	Specify a hotspot password.
<b>Frequency</b>	Set the hotspot frequency to 2.4 GHz or 5 GHz.

# Bluetooth

If a Wi-Fi dongle with the Bluetooth function is inserted, you can configure the Bluetooth settings.

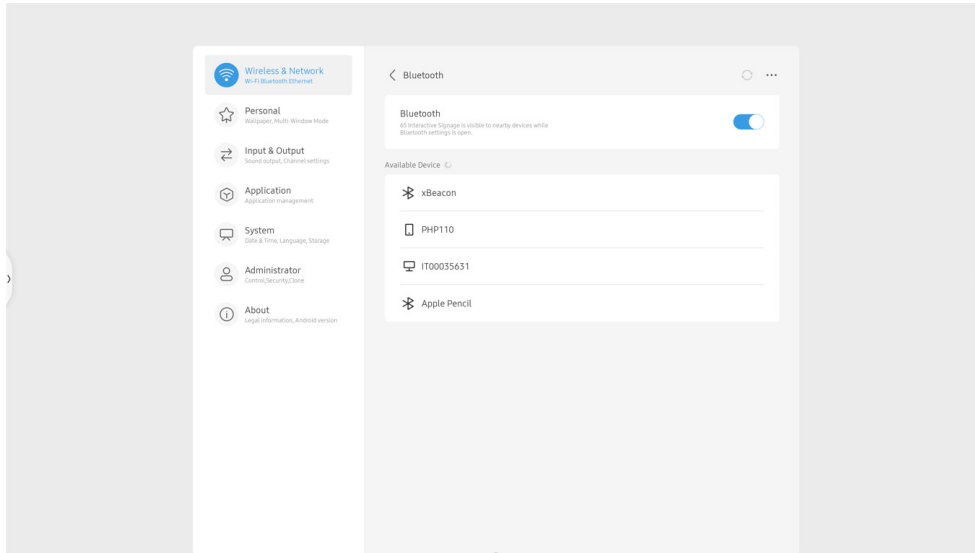

You can view the list of available nearby devices and connect to a Bluetooth device from the list. Then, you can configure the permission and type of the connected Bluetooth device.

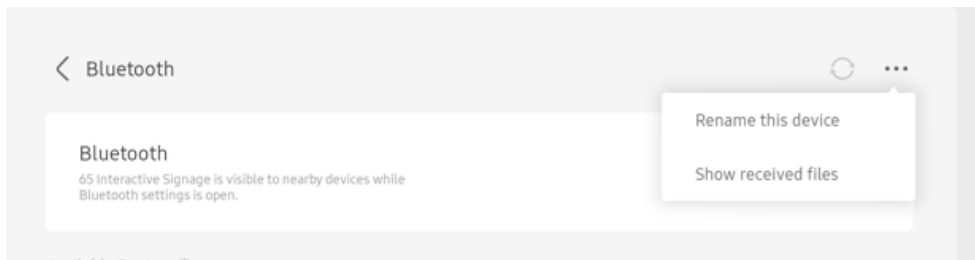

Tap the "...” icon in the top right corner to rename the current device or view received files.

# VPN

You can set up a virtual private network (VPN) for VPN-based network access.

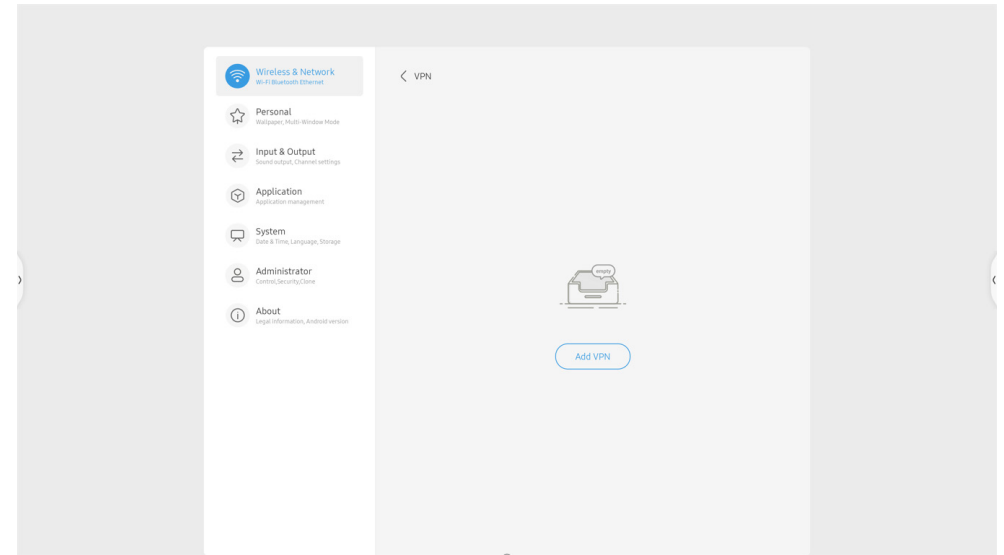

You can add a VPN profile based on your requirements.

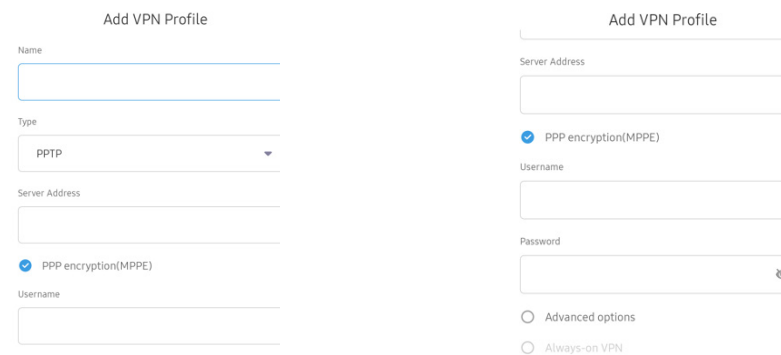

You can add a VPN profile based on your requirements.

## Samba Service

You can specify whether to toggle on the Samba service that allows file transfer between a personal device and the current device.

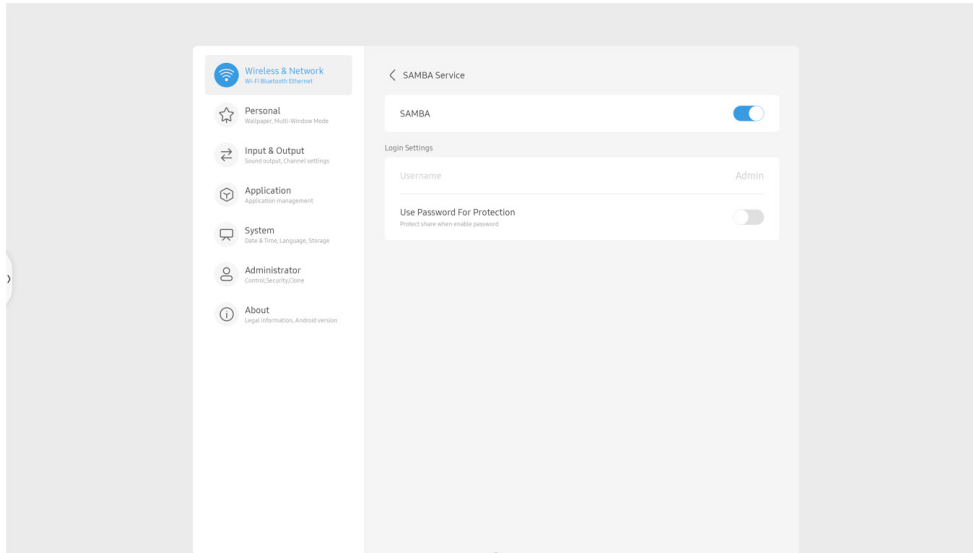

## Personal

You can customize system features based on your requirements.

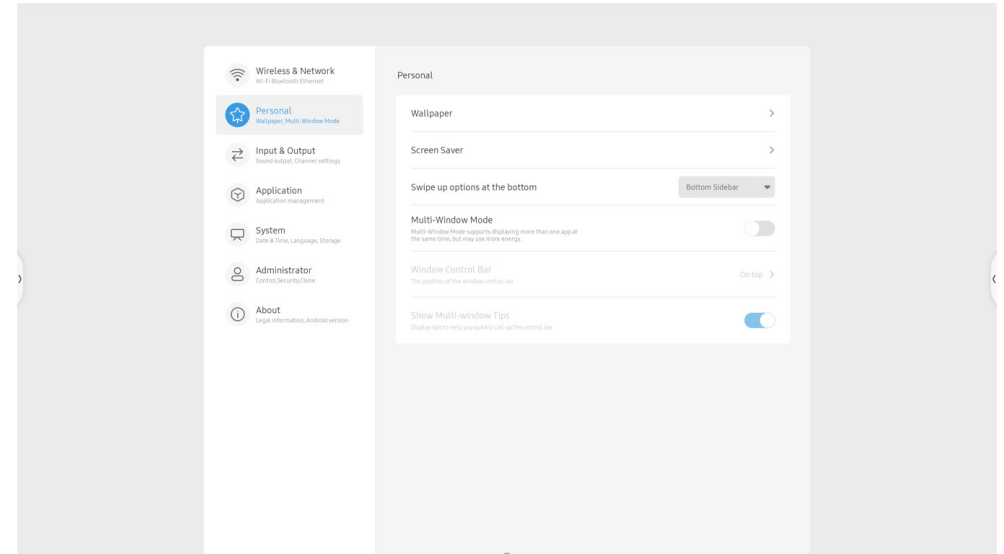

Item	Description
Wallpaper	Specify the wallpaper type and logo.
Screen Saver	Select the screen saver and specify the time to start it.
Swipe up options at the bottom	Configure the operations that correspond to <b>Swipe up options at the bottom</b> .
Multi-Window Mode	Toggle on/off <b>Multi-Window Mode</b> and other settings in this mode.

# Wallpaper

You can select a still or a dynamic wallpaper and customize the wallpaper logo based on your preference. Multiple still and dynamic wallpapers are available.

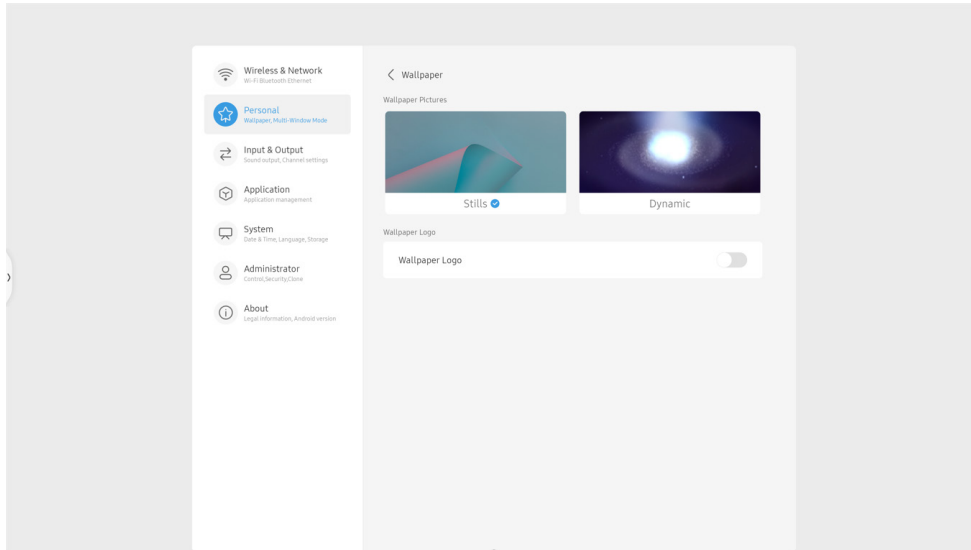

## Still wallpaper

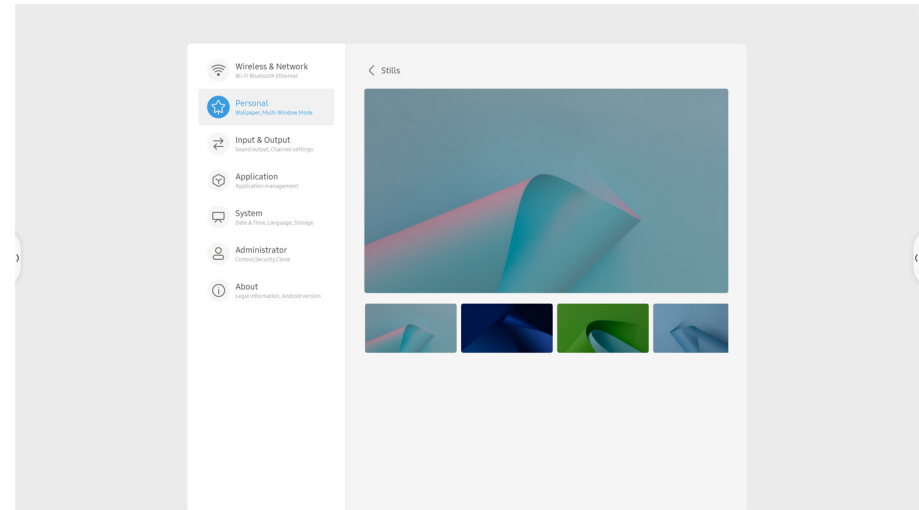

## Dynamic wallpaper

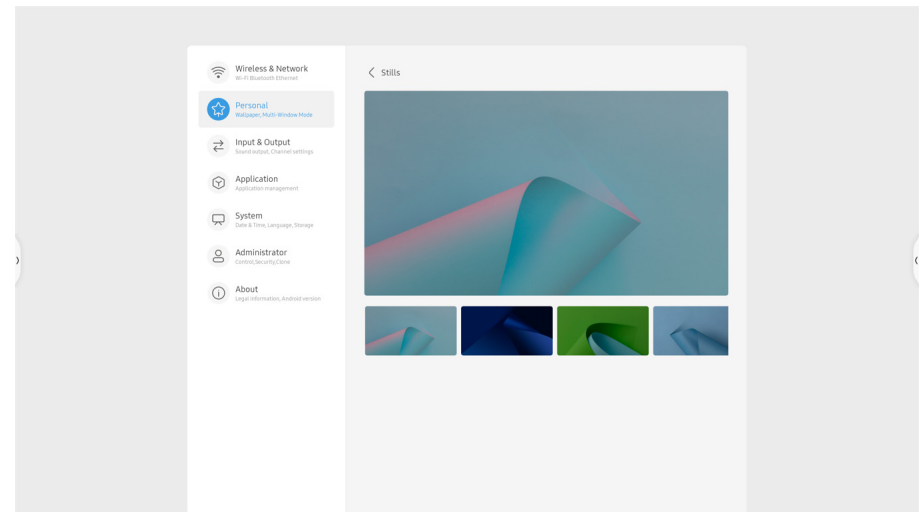

## Custom wallpaper logo

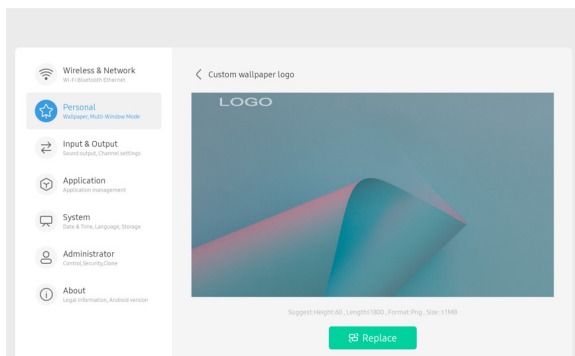

The custom wallpaper logo appears in the top left corner of the home screen.

## Screen Saver

You can set the screen saver to **Clock**, **Colors**, or **Landscape** and specify the time to start it. You can also preview the screen saver.

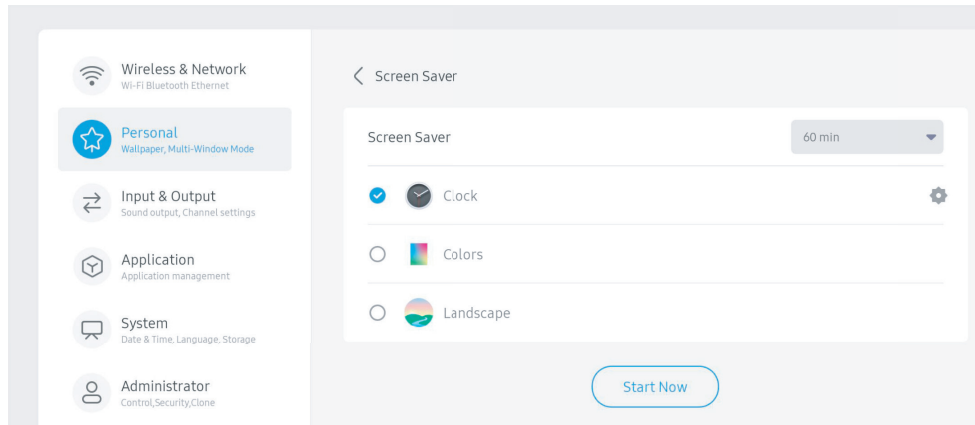

## Swipe up options at the bottom

You can set the following operations that correspond to **Swipe up options at the bottom**:

- Bottom Sidebar
- Menu

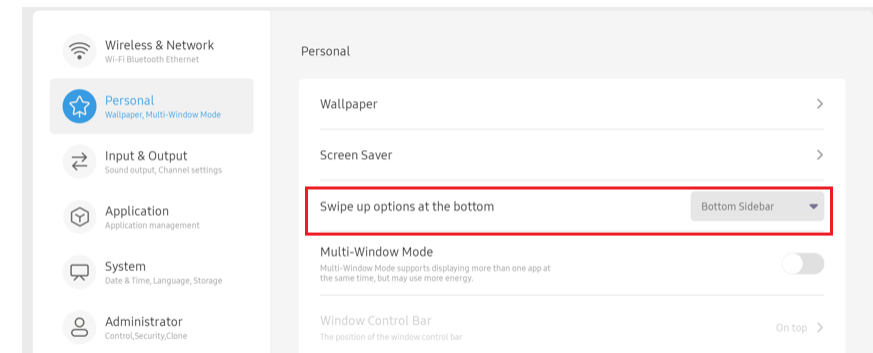

# Multi-Window Mode

The multi-window mode allows you to open multiple apps on the foreground at the same time.

You need to restart the system after toggling on **Multi-Window Mode**.

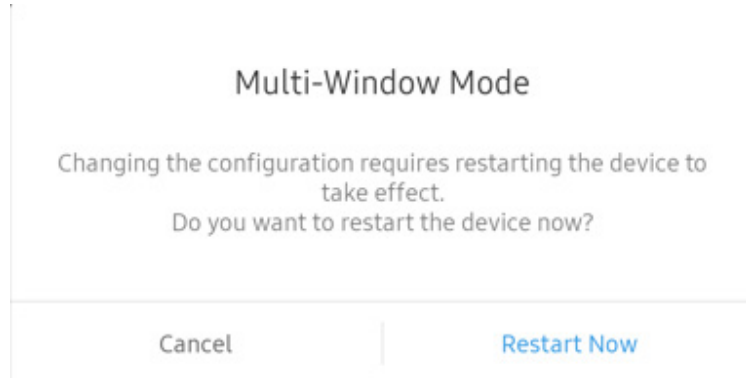

After the restart, opened apps are displayed in windows.

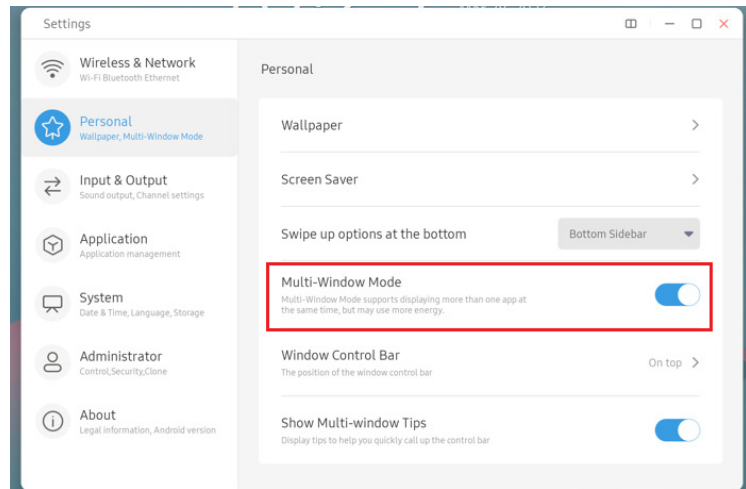

You can set **Position in the windows** on **Window Control Bar** to **On top**, **Left side**, or **Right side**.

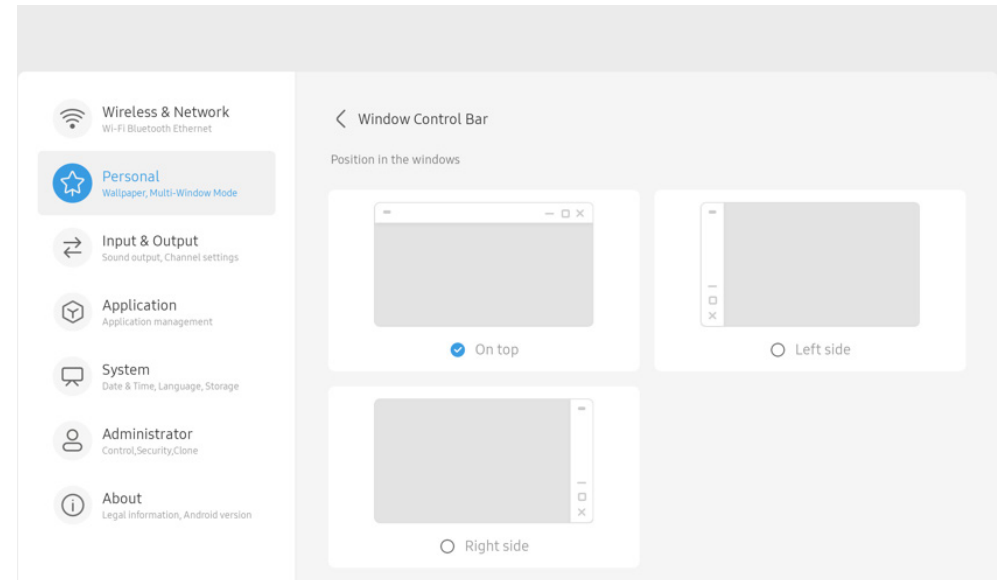

# Input & Output

Configure the system sound and image input and output.

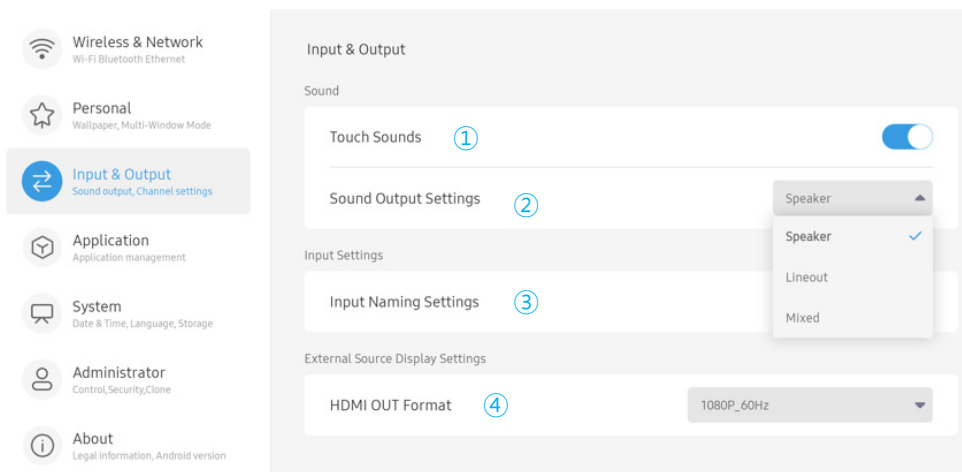

Item	Description
1 Touch Sounds	Toggle on/off Touch Sounds.
2 Sound Output Settings	Change the sound output channel.
3 Input Naming Settings	Rename the input source.
4 HDMI OUT Format	Change the HDMI OUT resolution and refresh rate.

# Sound Output Settings

You can configure the channel to output system sounds.

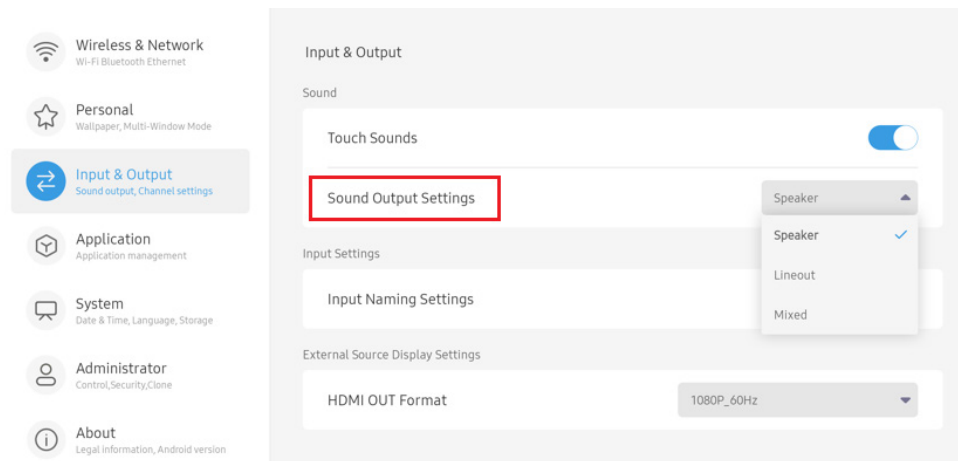

Item	Description
Speaker	The output is from the speaker of this device.
Lineout	The output is from the device that is connected to the rear AUDIO OUT interface.
Mixed	The output is from mixed sources.



## Input Naming Settings

You can rename an external signal source to a custom name for display.

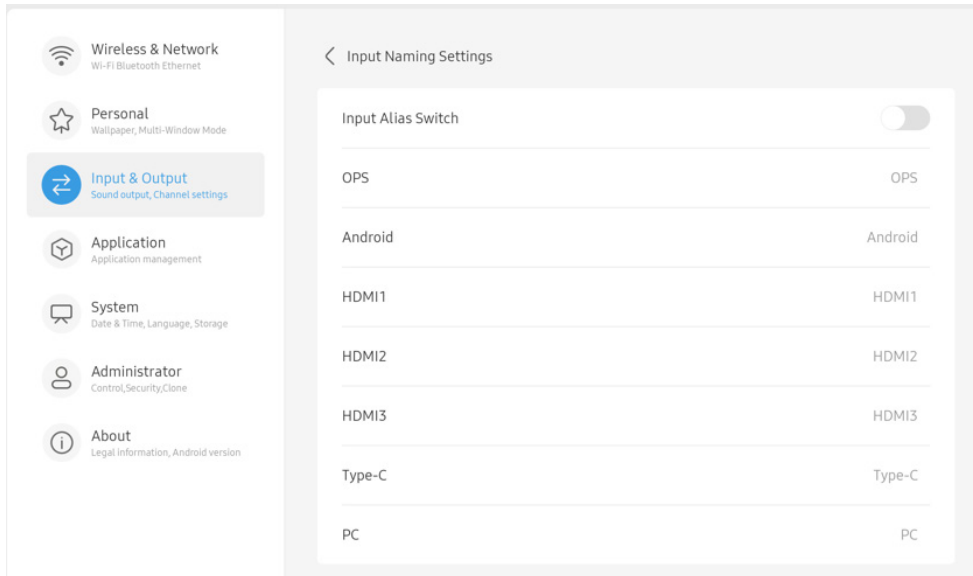

## HDMI OUT Format

You can set **HDMI OUT Format** to **3840x2160\_60Hz** or **1080P\_60Hz**.

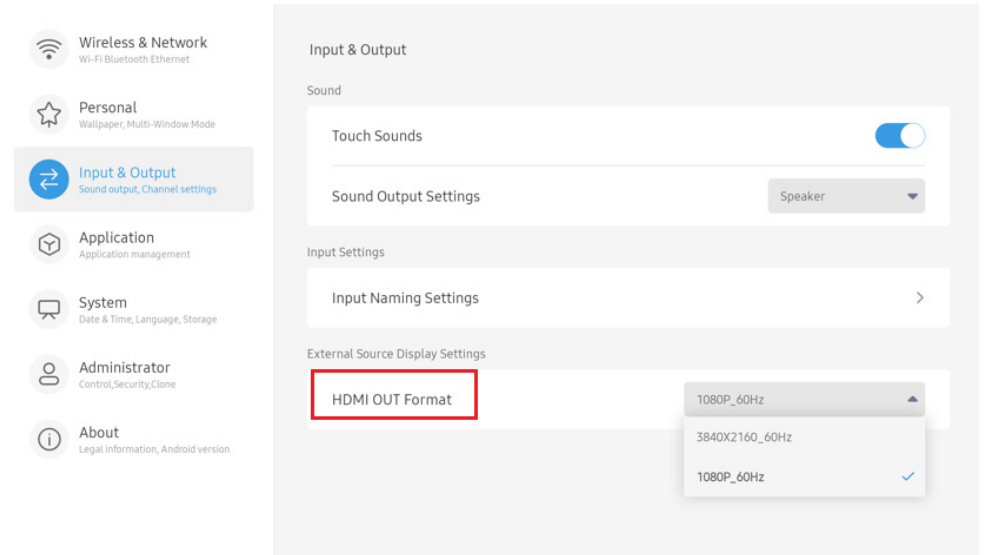

# Application

In **Application**, you can browse system apps and manage their permissions.

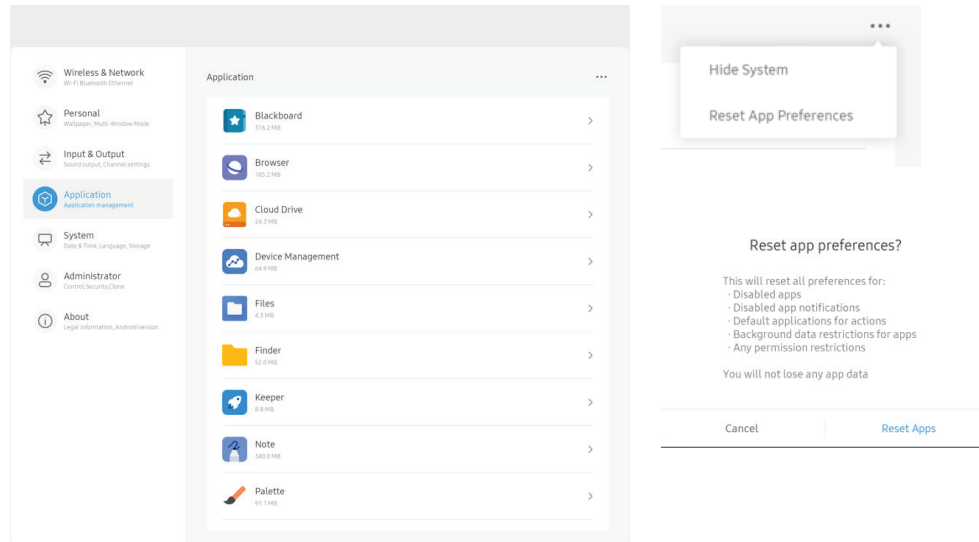

Tap the "... icon in the top right corner to reset app preferences.

You can apply the following settings to an app:

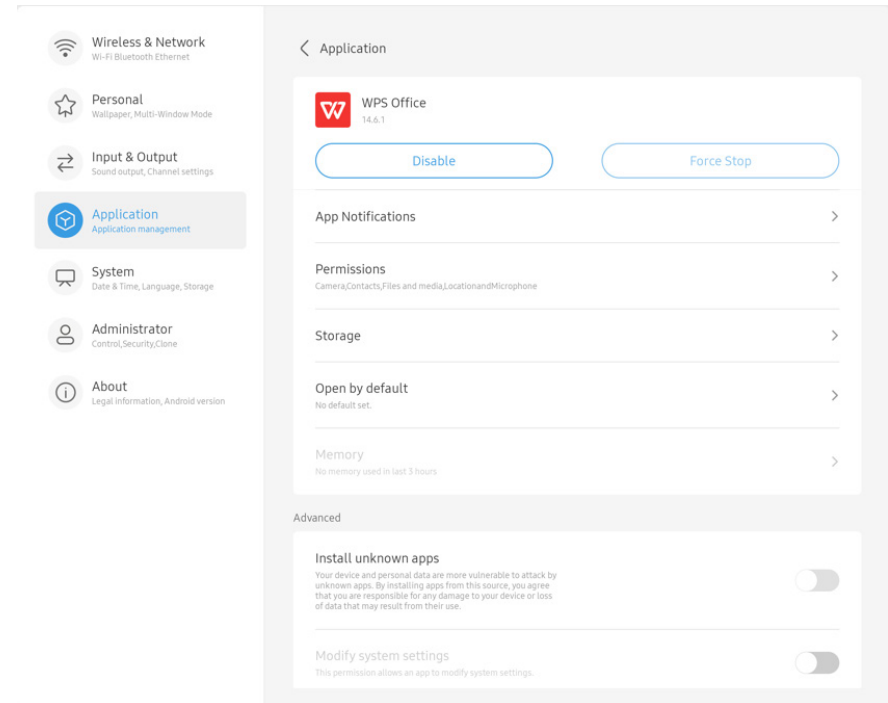

Option	Description
<b>Disable</b>	Disable/Enable the app.
<b>Force Stop</b>	Forcibly stop a running app.
<b>App Notifications</b>	Manage app notifications.
<b>Permissions</b>	Manage app permissions.
<b>Storage</b>	Manage the storage occupied by the app.
<b>Open by default</b>	Manage the Open by default setting for the app.
<b>Memory</b>	Manage the memory occupied by the app.
<b>Install unknown apps</b>	Toggle on/off Install unknown apps for the app.
<b>Modify system settings</b>	Toggle on/off Modify system settings for the app.

# System

System settings allow you to configure general system functions.

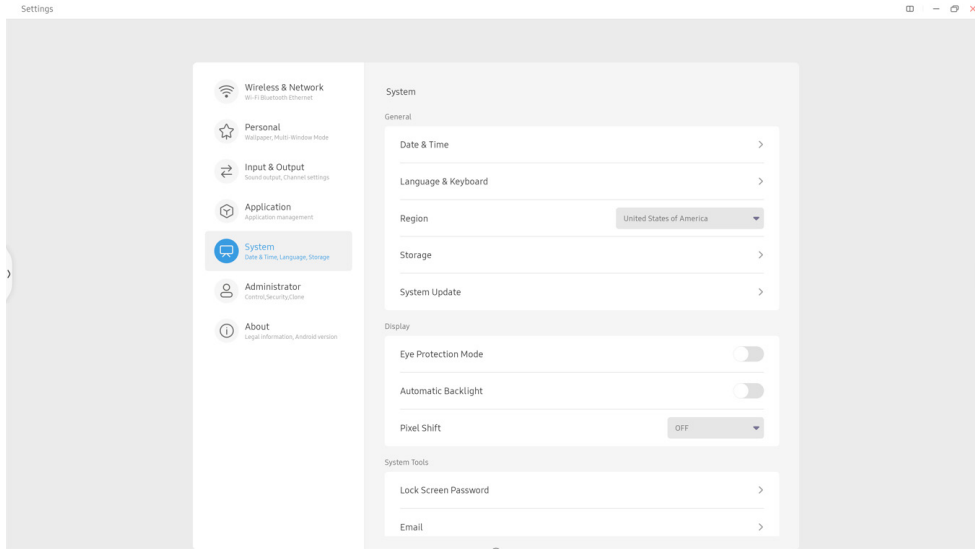

# Date & Time

You can specify the date and time format and the time zone of the system.

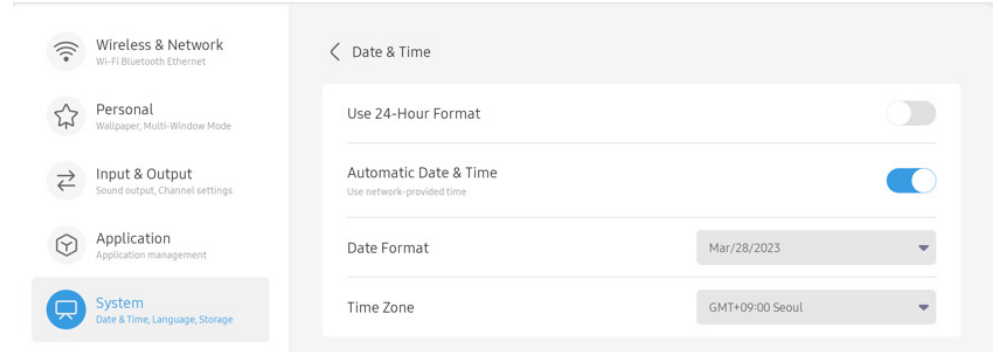

Item	Description
<b>Use 24-Hour Format</b>	Toggle on/off Use 24-Hour Format.
<b>Automatic Date &amp; Time</b>	Toggle on/off Automatic Date & Time. If you toggle off this option, you need to manually specify the date and time.
<b>Date Format</b>	You can specify the date in one of the following formats: <ul style="list-style-type: none"><li>• YYYY/MM/DD</li><li>• DD/MM/YYYY</li><li>• MM/DD/YYYY</li></ul>
<b>Time Zone</b>	Specify the time zone. The time zone is the basis for the automatic adjustment of the date and time.

## Language & Keyboard

You can configure the system language and keyboard.

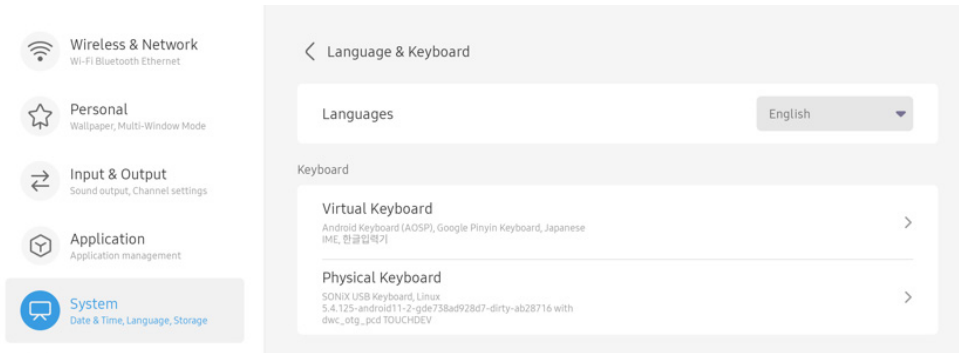

Item	Description
Languages	English, French, German, Italian, Polish, Portuguese, Russian, Spanish, Swedish, Greek, Cheskey, Slovak, Hungarian, Finnish, Turkish, South Arabic Language, Hebrew, Chinese (Traditional/Simplified), Japanese, Korean, Romania, Croatia, Lithuania, Serbian Latin, Norway, Denmark, Vietnam, Indonesia, Thailand, Kazakh (Cyrillic), Ukrainian, Bulgarian, Slovenian, Dutch, Latvia, Estonia, Hindi
Virtual Keyboard	<ul style="list-style-type: none"> <li>• Android Keyboard (ASOP)</li> <li>• Google Pinyin Keyboard</li> <li>• Japanese IME</li> <li>• Korean IME</li> </ul>
Physical Keyboard	<ul style="list-style-type: none"> <li>• Android Keyboard (ASOP) – English US</li> <li>• Google Pinyin Keyboard - Chinese</li> <li>• Japanese IME - Japanese</li> <li>• Korean IME - Korean</li> </ul>

## Region

You can specify the region. The system automatically limits the Wi-Fi band based on the restriction according to GDPR requirements.

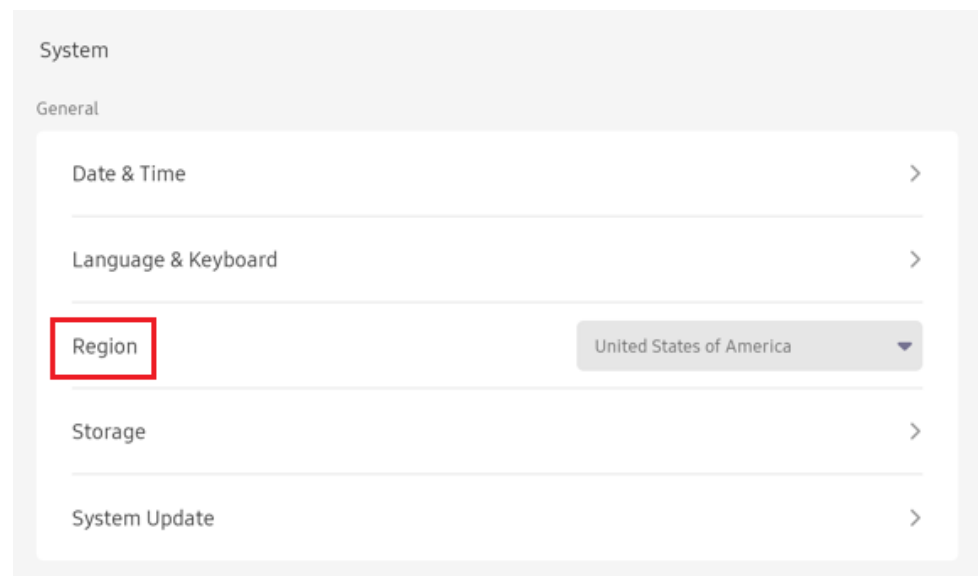

# Storage

You can view the internal storage space and the space occupied by different types of files.

## WA65C WA75C

- Wireless & Network
- Personal
- Input & Output

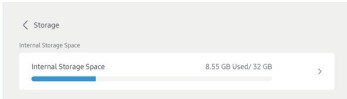

- Wireless & Network
- Personal
- Input & Output
- Application
- System
- Administrator
- About

Category	Size
System	5.7 GB
Apps	2.7 GB
Photos	139 MB
Files	311 KB
Videos	0 B
Audio	0 B
Others	0 B

## WA86C

- Wireless & Network
- Personal
- Input & Output



- Wireless & Network
- Personal
- Input & Output
- Application
- System
- Administrator
- About

Category	Size
System	7.7 GB
Apps	2.9 GB
Photos	198 MB
Files	3.7 MB
Videos	0 B
Audio	0 B
Others	0 B

To free up space, tap **Clean Up App Data** to enter the cleanup page and clear unnecessary app data.

- Wireless & Network
- Personal
- Input & Output
- Application
- System
- Administrator
- About



## System Update

This page allows you to view the current system version and check for updates.

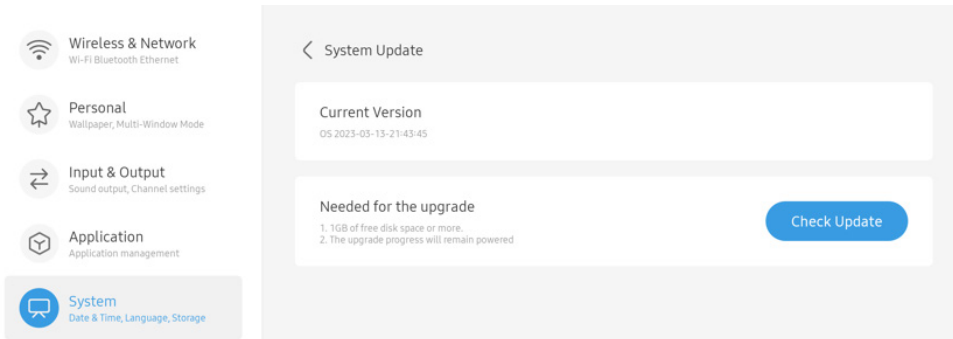

If no updates are found, the following window pops up.

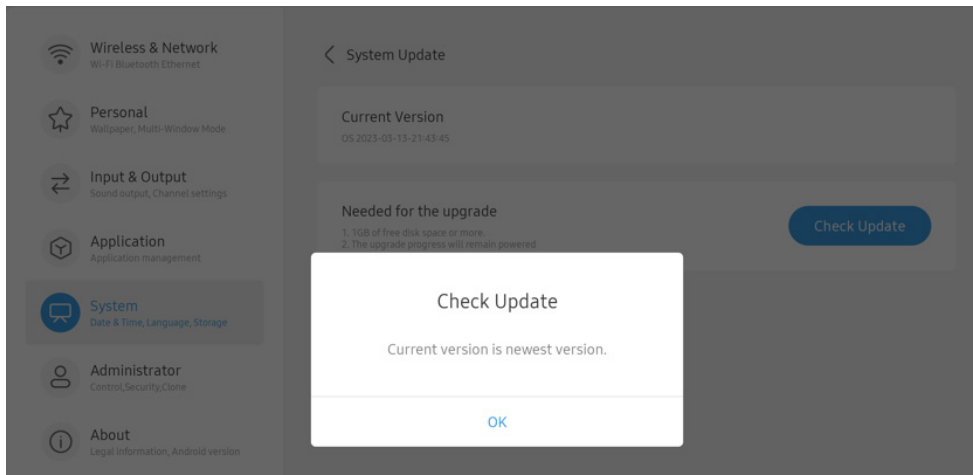

If an update is found, the update is downloaded. Then, you are asked whether to execute the update.

## Eye Protection Mode and Automatic Backlight

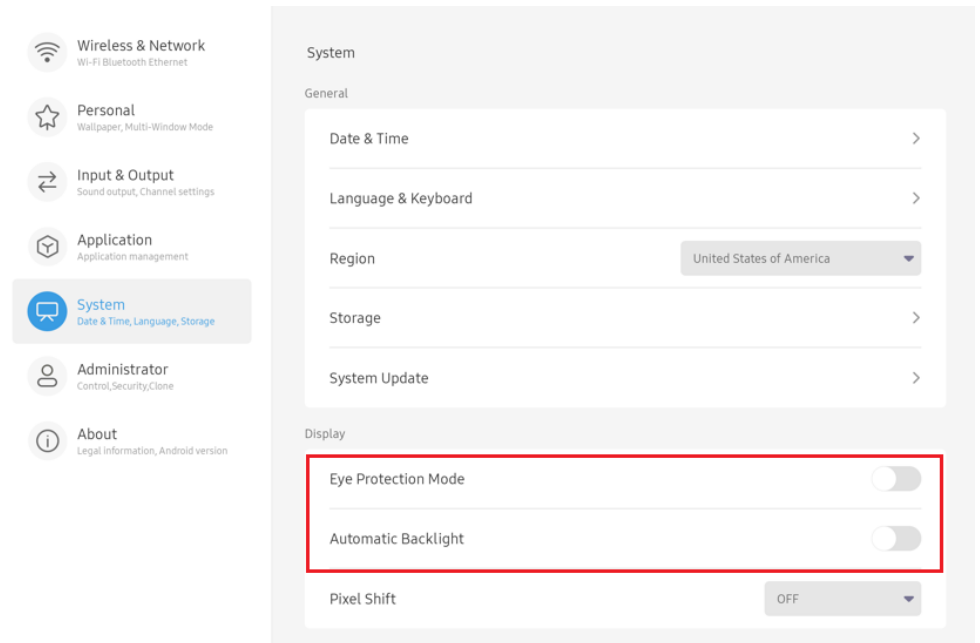

- If **Eye Protection Mode** is toggled on, the system shows warm colors on the screen for eye protection.
- If **Automatic Backlight** is toggled on, the system automatically adjusts the screen backlight value based on the ambient brightness for energy saving and eye protection.

## Pixel Shift

The pixel shift function is used to refresh the screen display through screen pixel jitter and shift when the device is on but idle for a long time. This prevents screen burn-in.

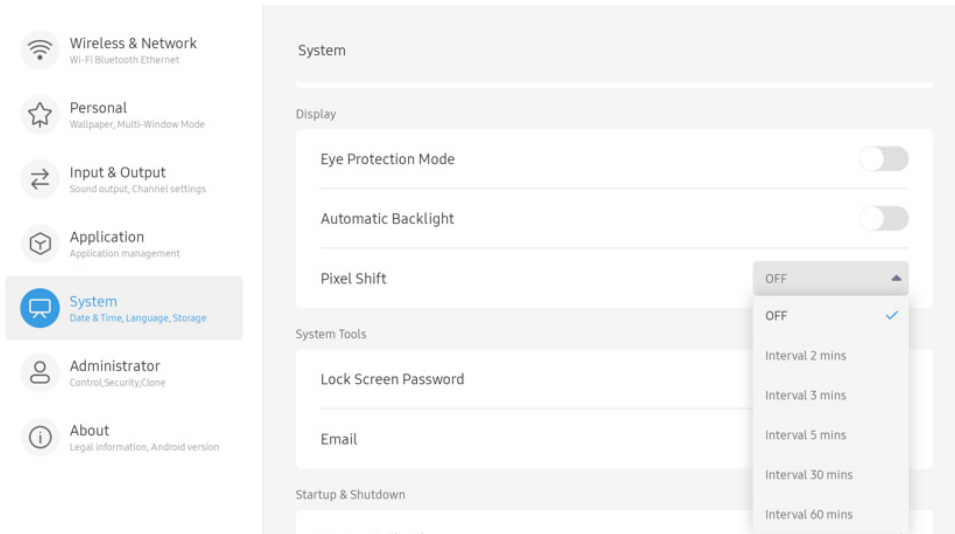

You can specify the pixel shift interval based on your requirements. We recommend that you specify a proper interval that is not too short to avoid affecting your operations.

## Lock Screen

### Password

The lock screen password is used to prevent unauthorized operations when the device is idle.

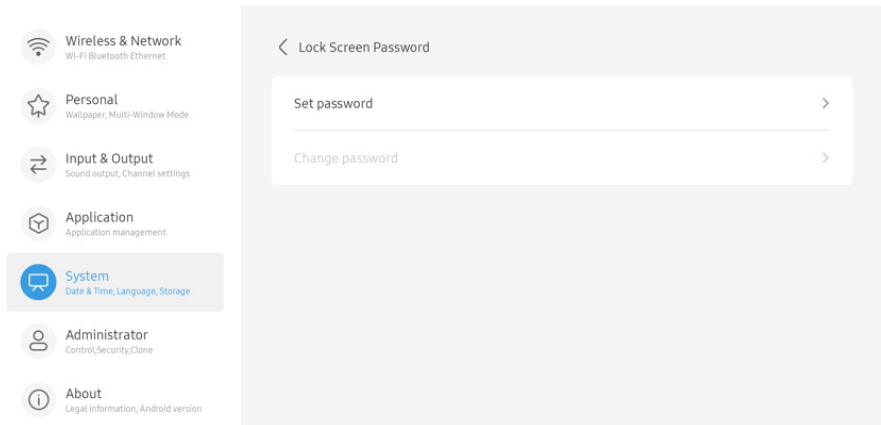

After setting up the lock screen password, you can tap **ScreenLock** on the sidebar to lock the screen.

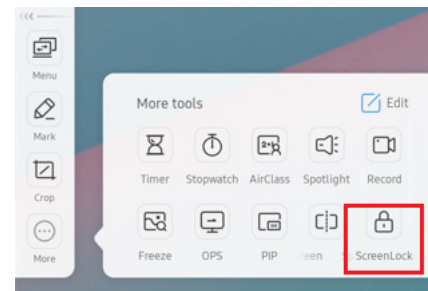
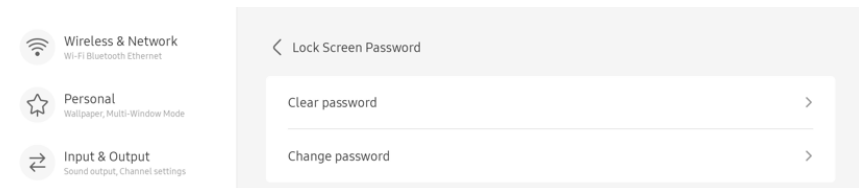

## Email Account

Setting up an Email account allows you to send files via Email in the file manager or Note app.

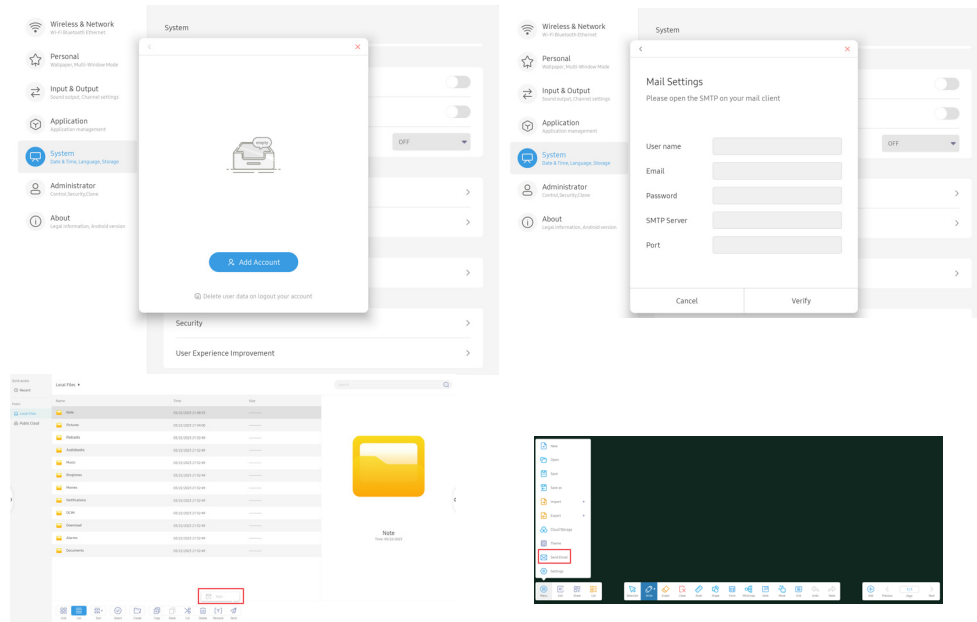

## Start up & Shut down

In Start up & Shut down, you can configure all relevant options.

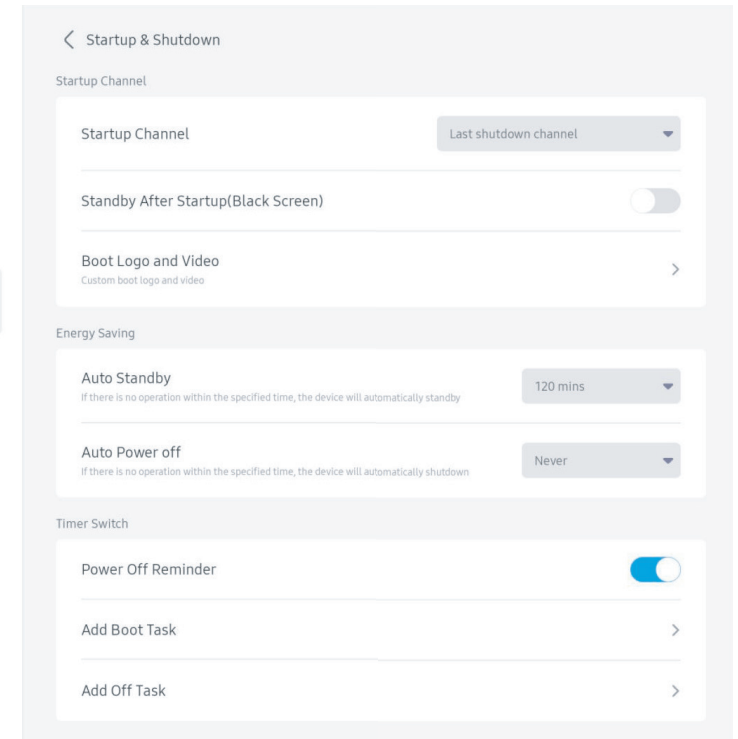
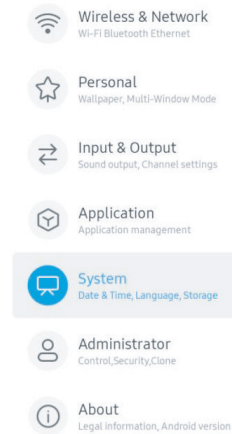

Item	Description
<b>Start up Channel</b>	After you configure a Start up channel, the channel is automatically entered upon Start up.
<b>Standby After Start up(Black Screen)</b>	If this option is toggled on, the screen automatically turns black every time the Interactive Display is started and enters the home screen.
<b>Boot Logo and Video</b>	You can customize the boot logo and video.
<b>Auto Standby</b>	If no operations are performed within a specified time, the system automatically enters standby mode.



Item	Description
<b>Auto Power off</b>	If no operations are performed within a specified time, the system automatically powers off.
<b>Power Off Reminder</b>	Toggle on this option to configure boot and off tasks.
<b>Add Boot Task</b>	You can specify the date and time for powering on the product.
<b>Add Off Task</b>	You can specify the date and time for powering off the product.

You can customize the boot logo and video on the following page.

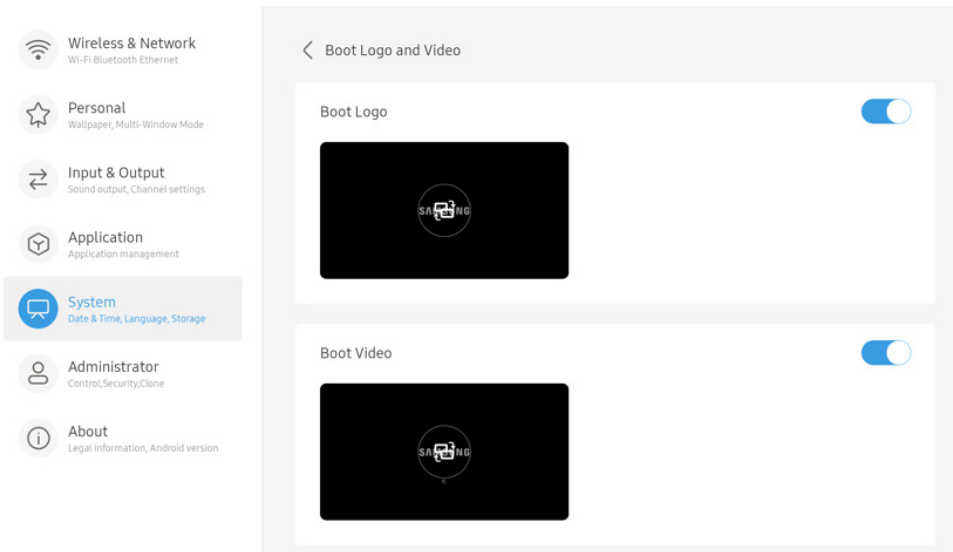

## Boot task settings (the same as off task settings)

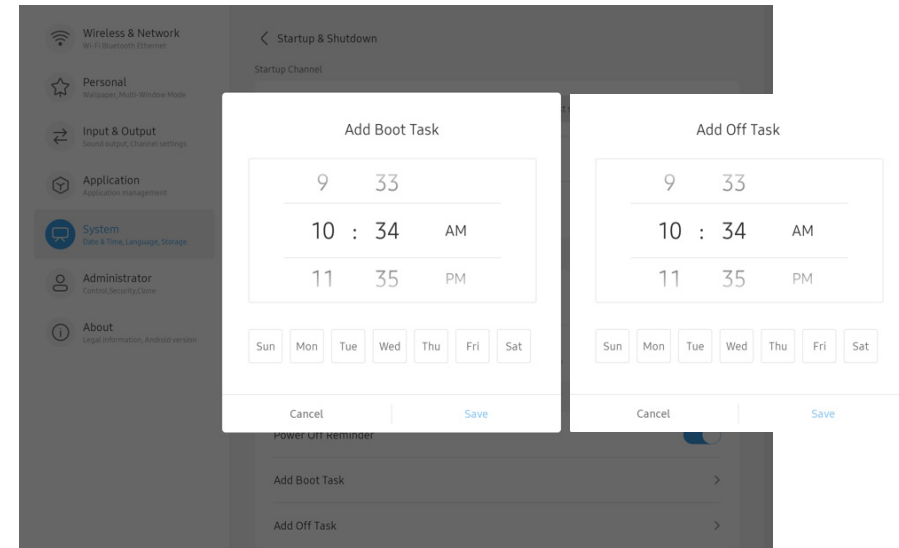

You can schedule a task on a specified day per week.

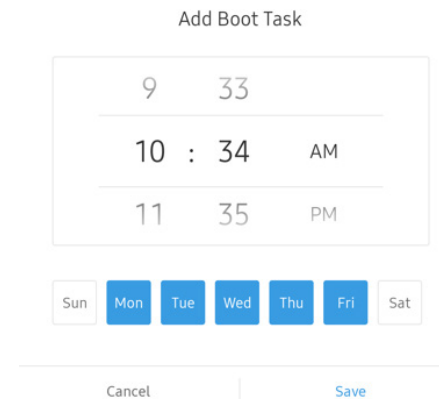

# Security

In the security settings, you can view the configured credentials in the system, including trusted and user credentials. Connecting to specific encrypted networks, such as TLS or PEAP requires a specific credential for validation.

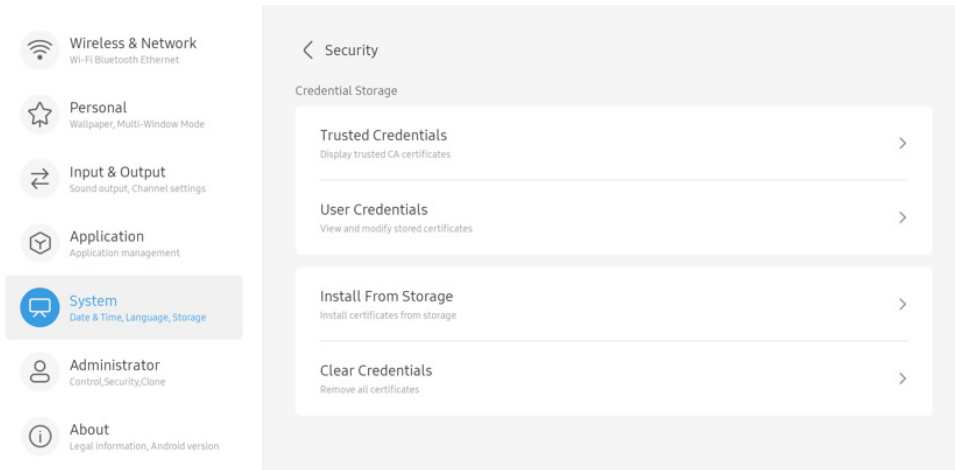

# Credential list

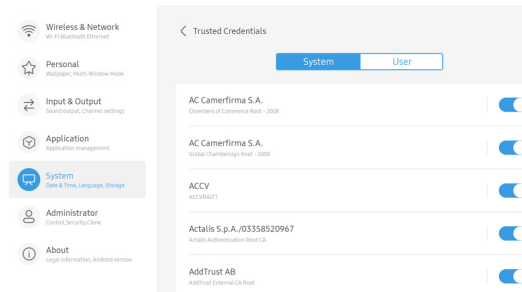

The following window pops up during credential clearing.

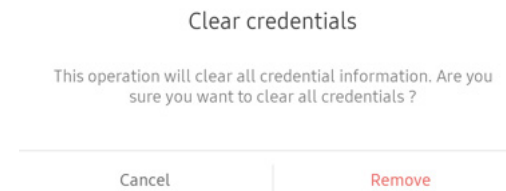

# Administrator

The administrator settings are usually used by device administrators to provide device control functions at a higher level.

To modify these settings, you need to specify an administrator password. Otherwise, all administrator settings become unavailable. Specifying an administrator password prevents ordinary users from modifying the options on this page without permissions.

If the administrator password is lost, press **Input** > **Up** > **Down** > **Back** on the remote control to clear the administrator password.

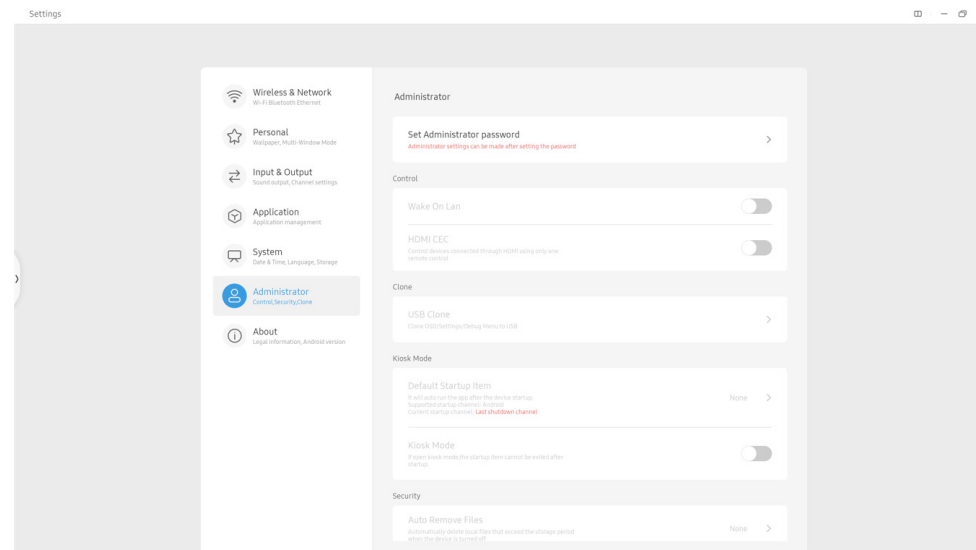

## Wake On Lan

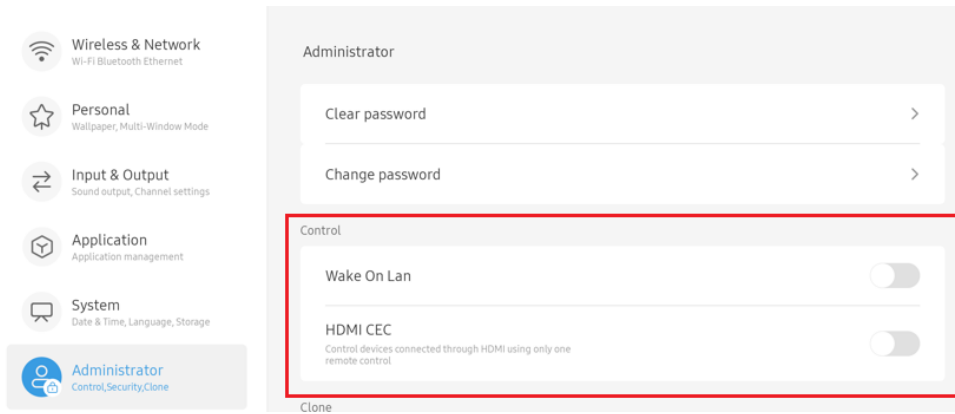

If **Wake on Lan** is toggled on and the device is connected to a network cable, the Start up instruction can be sent to the device in standby status via the network cable.

## HDMI CEC

If **HDMI CEC** is toggled on and the device that supports the CEC protocol is connected to the product via the HDMI cable, you can easily control the corresponding functions of the Interactive Display by using the remote control of the device.

## USB Clone

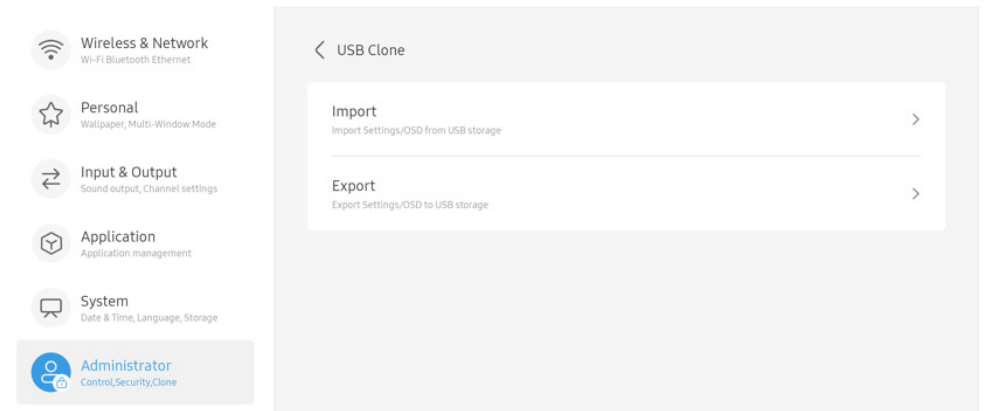

The USB clone function allows you to quickly export the system and on-screen display (OSD) settings from one Interactive Display to another.

## Default Start up Item

If the default Start up item is specified, the corresponding app/web page/document is automatically displayed after Start up.

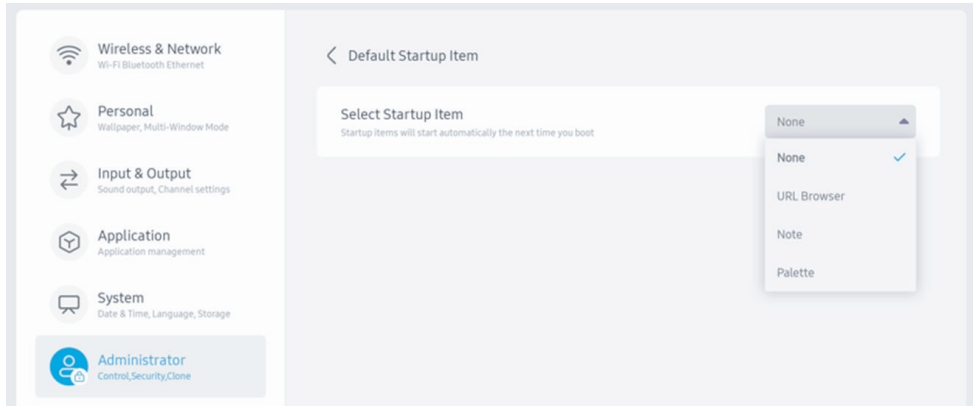

The following options are supported:

- URL Browser
- Note
- Palette

## Kiosk Mode

If the default Start up item is set to a specific content form, such as a web page, you can toggle on Kiosk Mode.

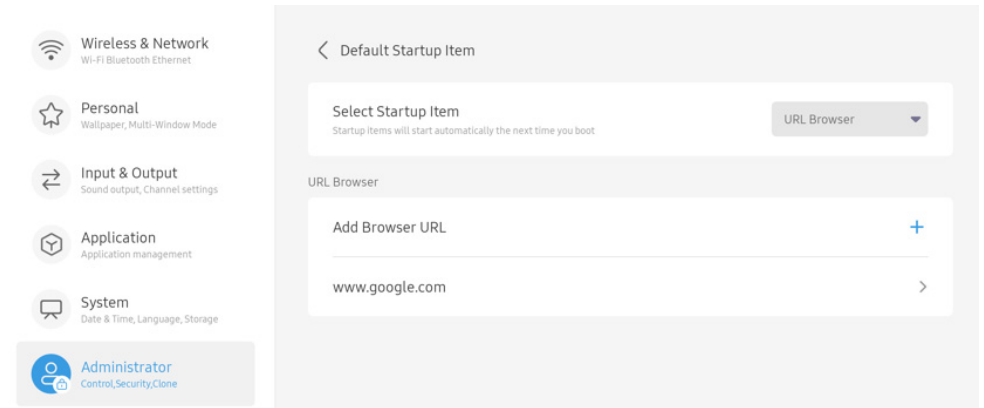

In kiosk mode, the content can be displayed but not manipulated.

### Kiosk Mode

If open kiosk mode, the startup item cannot be exited after startup.



Before the kiosk mode is toggled on, a window pops up to show the button combinations to exit the mode.

### Enter kiosk mode

Use remote control combination button(MENU UP DOWN LEFT RIGHT)to unlock

Cancel

Confirm

## Auto Remove Files

Set Auto Remove Files to prevent the Interactive Display from occupying a large storage space.

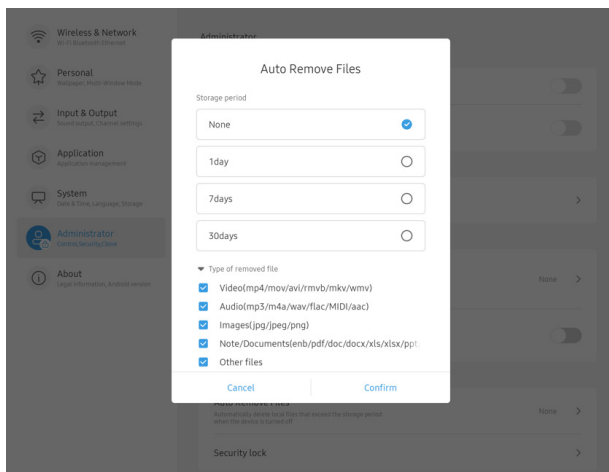

The storage period can be set to one of the following values:

**None, 1day, 7days, and 30days**

The following file types can be removed:

- Video
- Audio
- Image
- Document
- Others

## Security lock

You can toggle on/off system-level function locks.

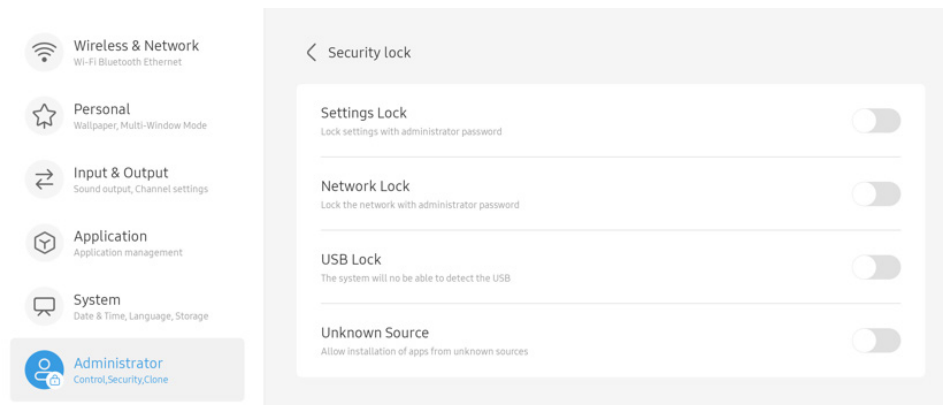

Item	Description
<b>Settings Lock</b>	Lock the system settings. The system settings can be unlocked only by using the administrator password.
<b>Network Lock</b>	Lock the network settings. The network settings can be unlocked only by using the administrator password.
<b>USB Lock</b>	When USB Lock is toggled on, USB-based connections cannot be recognized.
<b>Unknown Source</b>	After this option is toggled on, you can install apps from unknown sources.

# About

You can view basic system information.

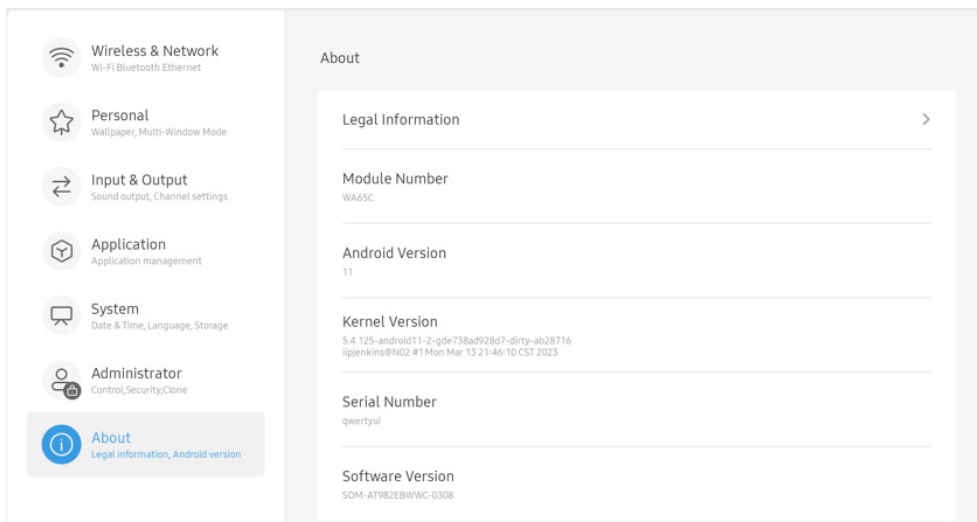

Item	Description
<b>Legal Information</b>	Third-party licenses Open source licenses 2 System Webview licenses
<b>Model Number</b>	Displays the model number of the device.
<b>Android Version</b>	Displays the Android version.
<b>Kernel Version</b>	Displays the system kernel version.
<b>Serial Number</b>	Displays the serial number of the device.
<b>Software Version</b>	Displays the software version of the device.

# OSD Menu

The OSD menu allows you to view and configure external signal sources, image display, and system sounds.



You can open the OSD menu by using one of the following methods:

Button on the status bar:



Button on the sidebar:

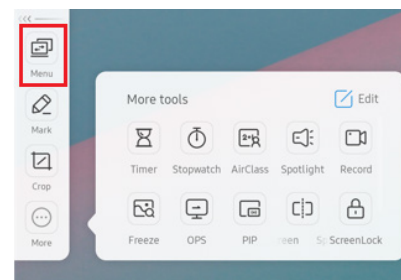

## Home screen

The home screen allows you to change the external signal source and adjust the system volume and brightness.



Item	Description
General	OPS/Android/HDMI1/HDMI2/HDMI3/PC/Type-C
Display	Adjust the system backlight brightness.
Audio	Adjust the system volume.

## Display

Adjust image display settings.

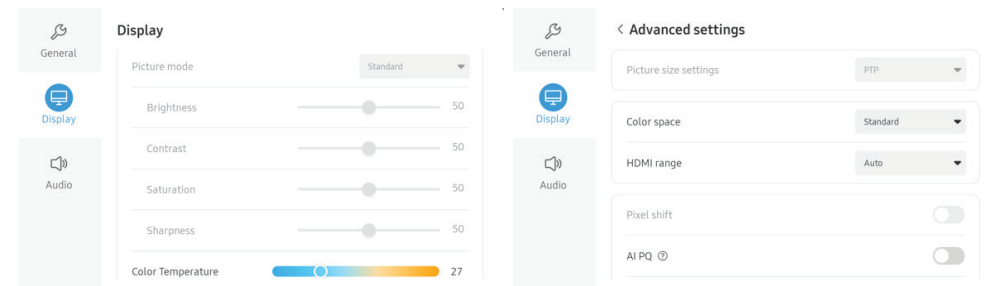

Item	Description
Auto brightness	When <b>Auto brightness</b> is toggled on, the system automatically adjusts the backlight brightness based on the ambient brightness.
Energy saving	When this option is toggled on, the system automatically turns off the screen if it detects that the ambient brightness is lower than the threshold (10) for one minute.



Item	Description
<b>Eye care</b>	When this option is toggled on, the system displays warm colors for eye protection.
<b>Paper eye care</b>	When this option is toggled on, the system makes a paper-like display for eye protection.
<b>Picture mode</b>	This option is valid only for external signal sources. You can select the preset picture mode or customize the following parameters: <ul style="list-style-type: none"> <li>Brightness</li> <li>Contrast</li> <li>Saturation</li> <li>Sharpness</li> </ul>
<b>Color Temperature</b>	You can adjust the color temperature value based on your requirements.
<b>Advanced settings</b>	Advanced settings include the following options: <ul style="list-style-type: none"> <li>Picture size settings: You can specify the aspect ratio. For example, you can set the aspect ratio to full screen.</li> <li>Color space: You can adjust the color space of the display.</li> <li>HDMI range: You can adjust the HDMI range.</li> <li>Pixel shift: You can specify whether to shift the screen image at a specific interval to prolong the life of the display.</li> <li>AI PQ: The gamma value of the image can be automatically adjusted based on the scenario to achieve the optimal display effect.</li> <li>Dynamic backlight (DCR): The contrast can be dynamically adjusted based on the displayed image.</li> </ul>

## Audio

Adjust system audio settings.



Item	Description
<b>Audio mode</b>	You can select a preset audio mode.
<b>Parameter adjustment</b>	When you set <b>Audio mode</b> to <b>Custom</b> , you can adjust the following audio parameters: <ul style="list-style-type: none"> <li>Bass</li> <li>Treble</li> </ul>
<b>Volume</b>	Adjust the volume.
<b>Balance</b>	Adjust the balance.
<b>Mute</b>	Toggle on/off <b>Mute</b> .

# Chapter 05

## Troubleshooting guide









### Problems and solutions

✎ Test your product as follows before calling Samsung Customer Service Center. If the problem persists, contact Samsung Customer Service Center.

Source window (HDMI) issue	
Blank spaces are found on all four sides of the screen when an HDMI cable is connected to the product and PC.	The blank spaces are not caused by the product.
	Blank spaces on the screen are caused by the PC or graphics card. To resolve the problem, adjust the screen size in the HDMI settings for the graphics card.
	If the graphics card settings menu does not have an option to adjust the screen size, update the graphics card driver to the latest version. (Please contact the graphics card or computer manufacturer for further details about how to adjust the screen settings.)
The images on the screen look distorted.	Check the connected cable. Compatibility is not guaranteed if you use a cable that has not been supplied by Samsung.
The screen is not clear. The screen is blurry.	Set the resolution and frequency to the recommended level.
The screen appears unstable and shaky.	Check that the resolution and frequency of the PC and graphics card are set within a range compatible with the product. Then, change the screen settings if required by referring to ' <a href="#">Preset timing modes</a> '.
There are shadows or ghost images left on the screen.	
White does not really look white.	Go to <b>Picture</b> and adjust the <b>White Balance</b> settings.
The product will turn off automatically.	Make sure the power cable is connected properly to the product and power outlet.

Source window (HDMI) issue	
The screen display does not look normal.	Encoded video content may cause the display to appear corrupted in scenes featuring fast moving objects such as in a sports event or action video.
	Low signal level or low picture quality may cause the display to appear corrupted. This does not mean the product is defective.
	A mobile device within a distance of one-meter radius may cause static on analogue and digital products.
The brightness and color do not look normal.	From the menu, select ☰ <b>Menu</b> → <b>SETTINGS</b> → <b>Picture</b> → <b>Reset Picture</b> to try resetting the screen.
The display looks unstable and then freezes.	The screen may freeze when a resolution other than the recommended resolution is used or if the signal is not stable. To resolve the issue, change the PC resolution to the recommended resolution.
The screen cannot be displayed in full screen.	If the source window is set to full screen mode while in portrait orientation, a black bar appears at both the top and bottom. Change to landscape orientation, and then switch the Source window to full screen mode.

Sound issue	
There is no sound.	Check the volume.
The volume is too low.	Adjust the volume.
	If the volume is still low after turning it up to the maximum level, adjust the volume on your PC sound card or software programme.
Video is available but there is no sound.	If a HDMI cable is connected, check the audio output settings on the PC.
	If a source device is used <ul style="list-style-type: none"> <li>• Check the audio output settings for the source device. (For example, if your monitor is connected to HDMI, you may need to change the audio option of your video output device to HDMI.)</li> </ul>
	Reconnect the power cable to the device and then reboot the device.
There is static coming from the speakers.	Low signal level can cause corrupted sound.
There is audible sound when the volume is muted.	Audio settings for main speakers are separate from the internal speakers on the product. Changing or muting the volume on the product does not affect an external amplifier(decoder).

Touch function issues	
The icons can be selected but does not allow drawing.	Use the provided product-specific pen.
Touching does not work when HDMI connection is used.	<p>Check whether the TOUCH  port on the product is connected to a USB port on the PC using the supplied USB cable.</p> <ul style="list-style-type: none"> <li>WA65C/WA75C/WA86C <ul style="list-style-type: none"> <li> HDMI  1 or  2 → TOUCH  1 on the rear of the product</li> <li> HDMI  3 → TOUCH  on the front of the product</li> </ul> </li> </ul>
When two pens are used, display has difficulty recognizing them.	Make sure that there is enough space between the two pens at multi-touching.
There is a screen touch malfunction such as slow or inaccurate responding.	Make sure that there are no foreign substances on the screen surface.
	Check whether the screen is broken.
	Make sure that the product is not exposed to direct sunlight.
	When the product is turned on after turning off, do not tap the screen because touch calibration is performed for 5 seconds.

HDMI-CEC issues	
Anynet+ does not work.	Check if the device is an Anynet+ device. The Anynet+ system supports Anynet+ devices only.
	Check if the Anynet+ device power cord is properly connected.
	Check the Anynet+ device's Video/Audio/HDMI cable connections.
	Check whether <b>Anynet+ (HDMI-CEC)</b> is set to <b>On</b> in <b>≡ Setting → Administrative → Control</b>
	Check whether the remote control is Anynet+ compatible.
	Anynet+ doesn't work in certain situations. (initial setup)
	If you have removed and then reconnected the HDMI cable, please make sure to search devices again or turn your product off and on again.
	Check if the Anynet+ function of the Anynet device turns on.
I want to start Anynet+.	Check if the Anynet+ device is properly connected to the product and check if <b>Anynet+ (HDMI-CEC)</b> is set to <b>On</b> in <b>≡ Menu → SETTINGS → External Device Manager</b> .
I want to exit Anynet+.	Press the <b>SOURCE</b> button on the product remote control and select a non-Anynet+ device.
The message " <b>Disconnecting Anynet+ device...</b> " appears on the screen.	You cannot use the remote control when you are configuring Anynet+ or switching to a view mode.
	Use the remote control after the product has completed Anynet+ configuration or has finished switching to Anynet+.
The Anynet+ device does not play.	You cannot use the play function when initial setup is in progress.

HDMI-CEC issues	
The connected device is not displayed.	Check whether or not the device supports Anynet+ functions.
	Check whether or not the HDMI cable is properly connected.
	Check whether <b>Anynet+ (HDMI-CEC)</b> is set to <b>On</b> in <b>Menu</b> → <b>SETTINGS</b> → <b>External Device Manager</b> .
	Search Anynet+ devices again.
	Anynet+ requires an HDMI connection. Make sure the device is connected to your product with an HDMI cable.
	Some HDMI cables may not support Anynet+ functions.
	If the connection is terminated because there has been a power failure or the HDMI cable has been disconnected, please repeat the device scan.
Other issue	
The product smells like plastic.	The plastic smell is normal and disappears over time.
Small particles are found on the edges of the product.	The particles are part of the product design. The product is not defective.
When I try to change the PC resolution, a message <b>"The defined resolution is not currently supported."</b> appears.	The message <b>"The defined resolution is not currently supported."</b> appears if the input source resolution exceeds the maximum resolution of the product. To resolve the issue, change the PC resolution to a resolution supported on the product.
There is no sound from the speakers in HDMI mode when a DVI-HDMI cable is connected.	DVI cables do not transmit sound data.
There is no sound in HDMI mode.	Displayed picture colors may not look normal. Video or sound may not be available. This can occur if a source device that only supports an older version of the HDMI standard is connected to the product.

# Chapter 06

## Specifications

### General

Model Name		WA65C	WA75C	WA86C
Panel	Size	65 CLASS (64.5 inches / 163.9 cm)	75 CLASS (74.5 inches / 189.3cm)	86 CLASS (85.6 inches / 217.4cm)
	Display area	1428.48 mm (H) x 803.52 mm (V)	1649.664 mm (H) x 927.936 mm (V)	1895.04 mm (H) x 1065.96 mm (V)
Synchronization (Panel Spec)	Horizontal Frequency	135 kHz		
	Vertical Frequency	60 Hz		
Resolution	Optimum resolution	3840 x 2160		
	Maximum resolution			
Power Supply		AC100-240V~ 50/60Hz Refer to the label at the back of the product as the standard voltage can vary in different countries.		
Environmental considerations	Operating	Temperature : 32 °F – 104 °F (0 °C – 40 °C) * For installing the enclosure, keep the internal temperature at 104 °F (40 °C) or below. Humidity : 10% – 80%, non-condensing		
	Storage	Temperature : -4 °F – 113 °F (-20 °C – 45 °C) Humidity : 5% – 95%, non-condensing * Applicable before the product package is unpacked.		

 **Horizontal Frequency:**  
The time required to scan a single line from the left to the right side of the screen is called a horizontal cycle. The reciprocal number of a horizontal cycle is called horizontal frequency. Horizontal frequency is measured in kHz.

 **Vertical Frequency:**  
The product displays a single image multiple times per second (like a fluorescent light) to display what the viewer sees. The rate of a single image being displayed repeatedly per second is called vertical frequency or refresh rate. Vertical frequency is measured in Hz.



---

 Due to the nature of the manufacturing of this product, approximately 1 pixel per million (1 ppm) may appear brighter or darker on the panel. This does not affect product performance.

 This product can be set to only one resolution for each screen size to obtain the optimum picture quality due to the nature of the panel. Using a resolution other than the specified resolution may degrade the picture quality. To avoid this, it is recommended that you select the optimum resolution specified for your product.

 For detailed device specifications, visit the Samsung website.

- Europe only (WA65C/WA75C/WA86C only)

To access energy labelling information about this product on the European Product Registry for Energy Labelling (EPREL), go to [https://eprel.ec.europa.eu/qr/\\*\\*\\*\\*\\*](https://eprel.ec.europa.eu/qr/*****) where \*\*\*\*\* is the product's EPREL registration number. You can find the registration number on the rating label of your product.

- Turkey only

To access the energy labelling information of the model: WA65C, WA75C, WA86C

(1) Go to [https://www.samsung.com/global/ecodesign\\_energy](https://www.samsung.com/global/ecodesign_energy)

(2) Get the model identifier from the energy label of the product and type it in the search box

(3) Energy labelling information can be found

## Preset timing modes

The screen will automatically be adjusted if a signal that belongs to the following standard signal modes is transmitted from your PC. If the signals transmitted from the PC differ from the standard mode, the screen may not be displayed. In such a case, change the settings as shown in the following table by referring to the graphics card user manual.

No.	Signal timing name	Reference	clock	Hf	Vf	HDMI	VGA	TypeC
			[MHz]	[KHz]	[Hz]			
1	720*400 @70Hz	IBM	28.322	31.788	70	/	Y	/
2	640*480 @60Hz	VESA	25.18	31.469	59.94	Y	Y	Y
3	800*600 @56Hz	VESA	36	35.156	56.25	/	Y	Y
4	800*600 @60Hz	VESA	40	37.879	60.317	Y	Y	Y
5	1024*768 @60Hz	VESA	65	48.363	60.004	Y	Y	Y
6	1280*768 @60Hz(RB)	CVTRB	68.25	47.396	59.995	Y	Y	Y
7	1280*768 @60Hz	VESA	79.5	47.776	59.87	Y	Y	Y
8	1280*800 @60Hz	VESA	83.5	49.702	59.81	Y	Y	Y
9	1280*960 @60.000Hz	VESA	108	60	60	Y	Y	Y
10	1280*1024 @60Hz	VESA	108	63.981	60.002	Y	Y	Y
11	1360*768 @60Hz	VESA	85.5	47.712	60.015	Y	Y	Y
12	1440*900 @60Hz(RB)	CVTRB	88.75	55.469	59.901	Y	Y	Y
13	1440*900 @60Hz	CVT	106.5	55.935	59.887	Y	Y	Y
14	1680*1050 60Hz	VESA	146.25	65.29	59.954	Y	Y	Y
15	1920*1080 60Hz	CEA	148.5	67.5	60	Y	Y	Y
16	640*480P594:3	CEA	25.175	31.469	59.94	/	/	Y
17	640*480P604:3	CEA	25.2	31.5	60	/	/	Y
18	720*480P604:3	CEA	27.027	31.5	60	/	/	Y
19	720*480P6016:9	CEA	27.027	31.5	60	/	/	Y
20	1280*720P5916:9	CEA	74.175	44.955	59.939	/	/	Y
21	1280*720P6016:9	CEA	74.25	45	60	/	/	Y
22	1440*480P604:3	CEA	54.054	31.5	60	/	/	Y
23	1440*480P5916:9	CEA	54	31.469	59.94	/	/	Y
24	1440*480P6016:9	CEA	54.054	31.5	60	/	/	Y
25	1920*1080P5916:9	CEA	148.35	67.432	59.939	/	/	Y
26	1920*1080P6016:9	CEA	148.5	67.5	60	/	/	Y

No.	Signal timing name	Reference	clock	Hf	Vf	HDMI	VGA	TypeC
			[MHz]	[KHz]	[Hz]			
27	720*576P504:3	CEA	27	31.25	50	/	/	Y
28	720*576P5016:9	CEA	27	31.25	50	/	/	Y
29	1280*720P5016:9	CEA	74.25	37.5	50	/	/	Y
30	1440*576P5016:9	CEA	54	31.25	50	/	/	Y
31	1920*1080P5016:9	CEA	148.5	56.25	50	/	/	Y
32	1920*1080P2316:9	CEA	74.175	26.973	23.976	/	/	Y
33	1920*1080P2416:9	CEA	74.25	27	24	/	/	Y
34	1920*1080P2516:9	CEA	74.25	28.125	25	/	/	Y
35	1920*1080P2916:9	CEA	74.175	33.716	29.97	/	/	Y
36	1920*1080P3016:9	CEA	74.25	33.75	30	/	/	Y
37	720(1440)*480i	CEA	27	15.734	59.939	Y	/	/
38	480p 59Hz	CEA	27	31.469	59.94	Y	/	/
39	480p 60Hz	CEA	27.027	31.5	60	Y	/	/
40	720(1440)*576i	CEA	27	15.625	50	Y	/	/
41	576p 50Hz	CEA	27	31.25	50	Y	/	/
42	720p 60Hz	CEA	74.25	45	60	Y	/	/
43	720p 59Hz	CEA	74.176	44.955	59.94	Y	/	/
44	720p 50Hz	CEA	74.25	37.5	50	Y	/	/
45	1080i 60Hz	CEA	74.25	33.75	60	Y	/	/
46	1080i 59Hz	CEA	74.176	33.716	59.94	Y	/	/
47	1080i 50Hz	CEA	74.25	28.125	50	Y	/	/
48	1080p 60Hz	CEA	148.5	67.5	60	Y	/	/
49	1080p 50Hz	CEA	148.5	56.25	50	Y	/	/
50	1080p 30Hz	CEA	74.25	33.75	30	Y	/	/
51	1080p 29Hz	CEA	74.176	33.716	29.97	Y	/	/
52	1080p 25Hz	CEA	74.25	28.125	25	Y	/	/
53	1080p 24Hz	CEA	74.25	27	24	Y	/	/
54	1080p 23Hz	CEA	74.176	26.973	23.976	Y	/	/
55	3840*2160 60Hz	CEA	594	135	60	Y	/	Y
56	3840*2160 50Hz	CEA	594	112.5	50	Y	/	Y
57	3840*2160 30Hz	CEA	297	67.5	29.97	Y	/	Y
58	3840*2160 25Hz	CEA	297	56.25	25	Y	/	Y
59	3840*2160 24Hz	CEA	297	54	23.982	Y	/	Y

# Chapter 07

## Appendix

### Responsibility for the pay service (Cost to customers)

 When the service is requested, in spite of in warranty, we may charge you for a visit from a service technician in the following cases.

#### Not a product defect

Cleaning of the product, Adjustment, Explanation, Re-installation and etc.

- If a service technician is requested to give instructions on how to use product or simply adjusts options without disassembling product.
- If a defect is caused by external environmental factors (Internet, Antenna, Wired Signal, etc.)
- If a product is reinstalled or devices are connected additionally after installing the purchased product for the first time.
- If a product is reinstalled to move to a different spot or to move to a different house.
- If the customer requests instructions on how to use another company's product.
- If customer requests instructions on how to use the network or another company's programme.
- If customer requests software installation and setup for the product.
- If a service technician removes/cleans dusts or foreign materials inside of the product.
- If customer requests an installation additionally after purchasing a product through home-shopping or online.

### A product damage caused by customer's fault

Product damage caused by customer's mishandling or wrong repair

If a product damage is caused by;

- External impact or drop.
- Use of supplies or separately sold product unspecified by Samsung.
- Repair from a person besides an engineer of outsourcing service company or partner of Samsung Electronics Co., Ltd.
- Remodeling or repairing the product by customer.
- Using it with incorrect voltage or non-authorized electrical connections.
- Not following the "cautions" in User Manual.

#### Others

- If product fails by natural disaster. (lightning, fire, earthquake, flood damage, etc)
- If consumable components are all used up. (Battery, Toner, Fluorescent lights, Head, Vibrator, Lamp, Filter, Ribbon, etc.)

 If customer requests a service in case the product has no defect, service fee may be charged. So please read User Manual first.

---

## Prevention of afterimage burn-in

### What is afterimage burn-in?

Afterimage burn-in should not occur when the panel is operating normally. Normal operation refers to a continuously changing video pattern. If the panel displays a fixed pattern for an extended period of time a slight voltage difference may occur between the electrodes in pixels that control the liquid crystals.

Such a voltage difference between electrodes increases with time and makes the liquid crystals thinner. When this occurs, a previous image can remain on the screen when the pattern changes.

-  This information is a guide to prevent afterimage burn-in. Viewing a fixed screen for an extended period of time may cause afterimage burn-in. This problem is not included in warranty.

### Recommended prevention practices

Viewing a fixed screen for an extended period of time may cause afterimage burn-ins or smudges. Turn off the product when it is not used for a long time, activate the Power Saving mode, or run a moving screen saver.

## HDMI License notice



The terms HDMI and HDMI High-Definition Multimedia Interface, and the HDMI Logo are trademarks or registered trademarks of HDMI Licensing Administrator, Inc. in the United States and other countries.

---

### Open Source License Notice

Open Source used in this product can be found on the following webpage (<https://opensource.samsung.com>).

---

---

## Low Blue Light

Low Blue Light (software solution) filters out blue light to protect your eyes by adjusting how much blue light is shown:

1. To open blue light setting: on an device home screen, swipe up from the bottom
2. In the middle of “General Setting”, the function low blue light is called “Eye Care”.
3. Tap the item “Eye Care” to enable/disable low blue light.

### Tips for eye health

Eye exercises can help minimize eye strain. Slowly roll your eyes to the up, down, left and right. Repeat as many times as needed.

When viewing screens for extended periods, it is recommended to take periodic breaks from viewing. Short breaks of at least 10 minutes are recommended after one (1) hour of continuous viewing.

While taking breaks, users can further reduce eye strain and dryness by focusing on objects that are further away from them for 10-15 seconds, then gaze at something up close for 10-15 seconds. Repeat this up to 10 times.

This exercise reduces the risk of your eyes’ focusing ability to “lock up” after prolonged computer work.

## ENERGY STAR

ENERGY STAR is a U.S. Environmental Protection Agency voluntary program that helps businesses and individuals save money and protect our climate through superior energy efficiency. Products that earn the ENERGY STAR prevent greenhouse gas emissions by meeting strict energy efficiency criteria or requirements set by the U.S. Environmental Protection Agency. The following logo appears on all ENERGY STAR-certified models:

This product qualifies for ENERGY STAR in the “Standard mode” setting and this is the setting in which power savings will be achieved. Changing the Standard mode picture settings or enabling other features will increase power consumption that could exceed the limits necessary to qualify for ENERGY STAR rating. Refer to EnergyStar.gov for more information on

